



Fire Smoke Damper (FSD) and Smoke Control Systems (SCS) Testing Requirements



But we have Sprinklers...

- According to the National Fire Protection Association (NFPA), smoke travels at 120-420 feet per minute (fpm) during an active fire.
- Most victims are not located in the same room as the fire's origin.
- Statistics show that approximately 70 percent of all building-related deaths are associated with smoke inhalation.

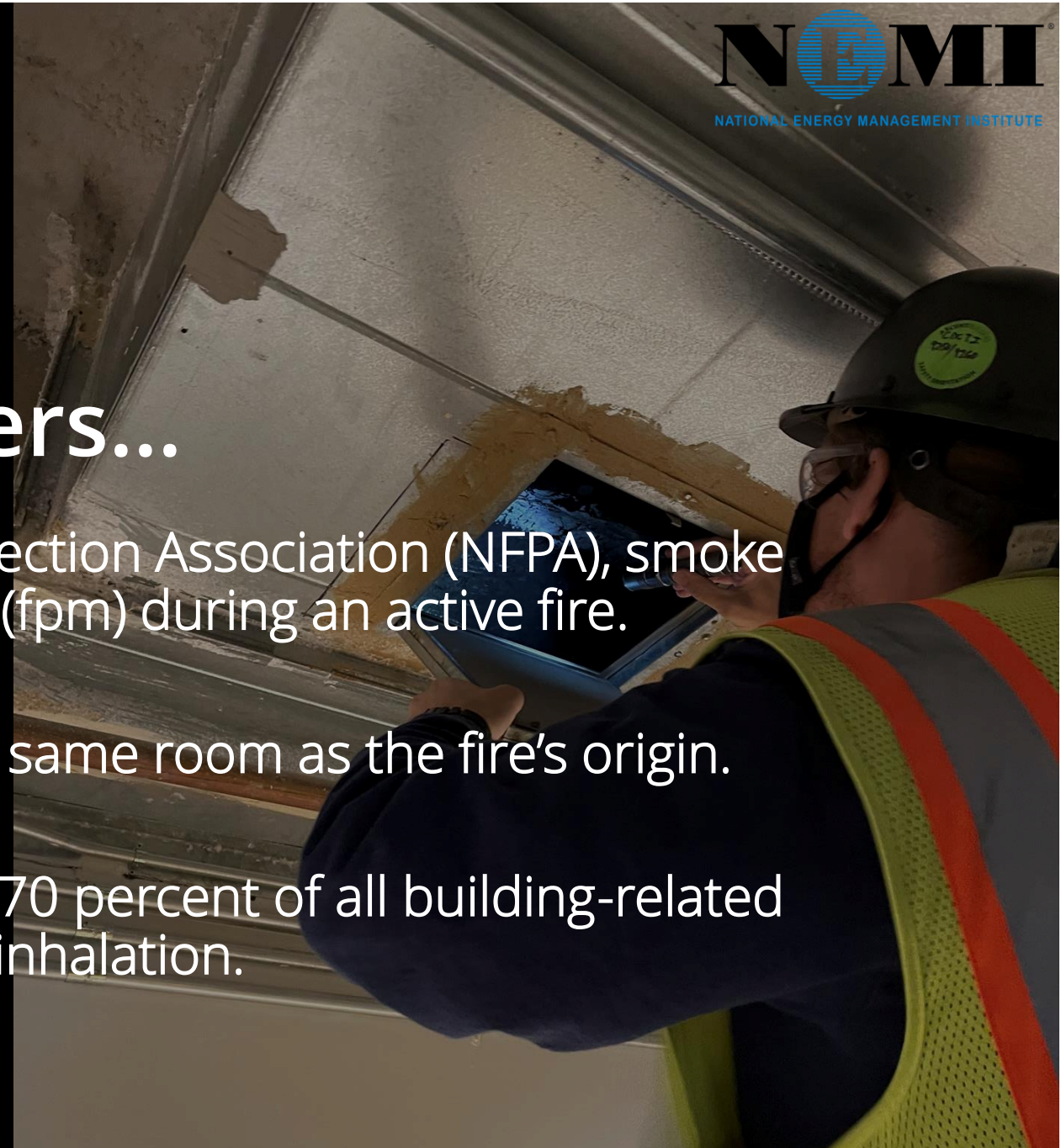

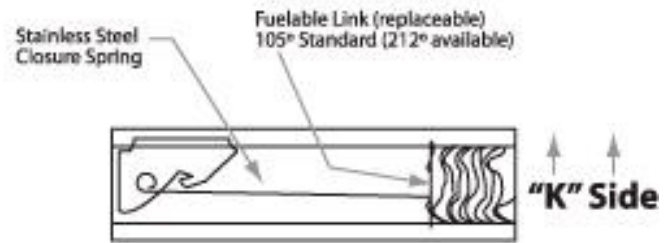
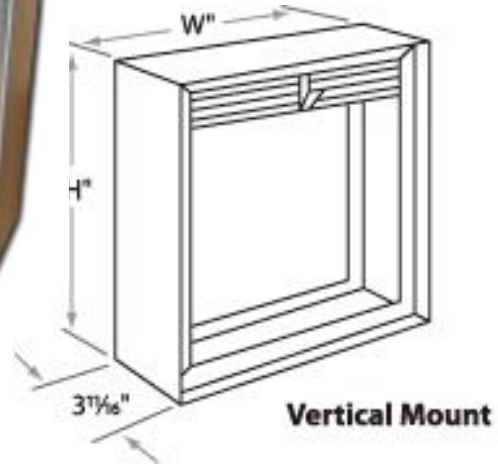

* These dimensions are furnished approximately 1/4" (6 mm) undersize. (Add sleeve thickness for overall sleeved damper dimension)



Fire Dampers



Smoke Dampers



Combination Fire and Smoke Dampers

Open



Closed

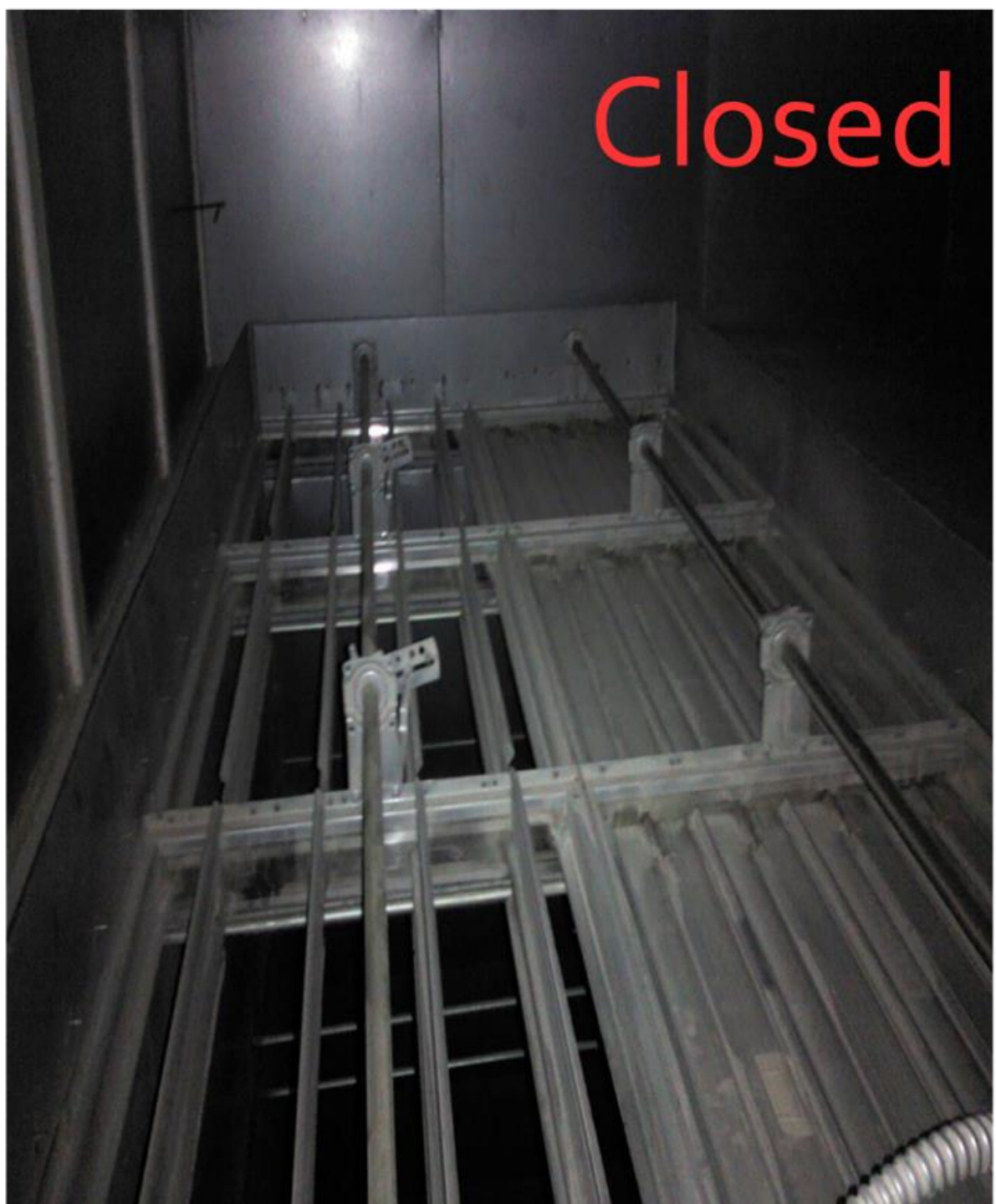



FSS 20/25

B. #3 EXT. 7-7/16

WARNING
DO NOT TOUCH
THIS SURFACE
IT IS HOT



UNDERWRITERS' L
CLAS
FIRE D
FINE RESISTANCE
RATING: 1 1/2 HR.
SEE U.L. CLASSIFIED BU
RUSKIN





SP100EZ
INDICATOR FOR LOCK POSITION
USE WITH THE SP100EZ LOCK
INDICATOR FOR LOCK POSITION
USE WITH THE SP100EZ LOCK

SP100EZ
INDICATOR FOR LOCK POSITION
USE WITH THE SP100EZ LOCK
INDICATOR FOR LOCK POSITION
USE WITH THE SP100EZ LOCK

1/2



















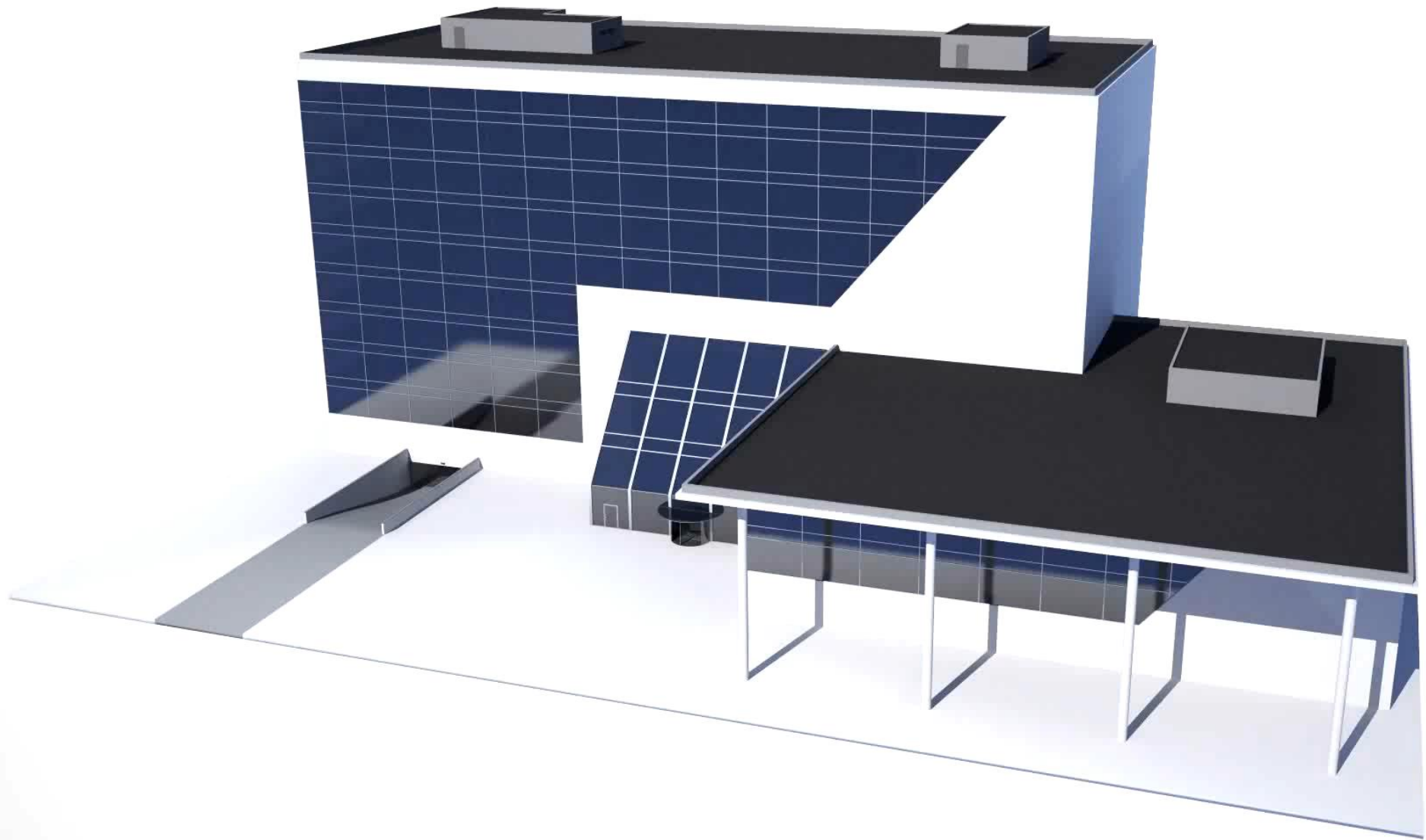

University of Maryland Study

RELIABILITY OF FIRE DAMPERS, SMOKE DAMPERS AND SMOKE CONTROL SYSTEMS

- ✓ Released July 21, 2021
- ✓ 170,354 dampers included
- ✓ 53% of dampers in existing buildings needed repairs
- ✓ 3,653 dampers needed replacement
- ✓ 20,550 needed better access installed

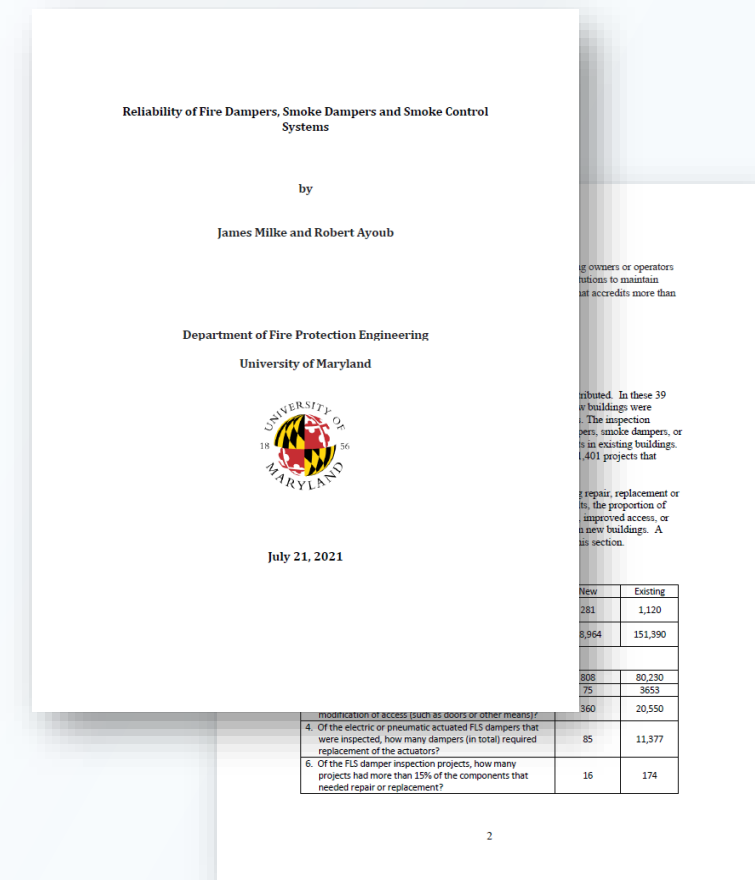



Local Code

What is Required?





Periodic Damper Inspections

Current
Requirements

City of Portland
2023





Current requirements for the city of **Portland, OR**

2021 Portland Fire Code is based on the 2019 Oregon Fire Code





2019 Oregon Fire Code

The 2019 Oregon Fire Code is based on the 2018 International Fire Code (IFC).



The 2022 Oregon Fire Code went into effect on October 1, 2022

- Based upon the 2021 edition of the *International Fire Code (IFC)* as published by the International Code Council (ICC)

Fire Smoke Dampers (FSD)



2018 & 2021 International Fire Code (IFC)



Calls for FLS dampers to be inspected and maintained in accordance with NFPA 80 and 105.

Section 706 Duct And Air Transfer Openings

- 706.1 Maintaining protection. Dampers protecting ducts and air transfer openings shall be **inspected and maintained in accordance with NFPA 80 and 105**. Other products or materials used to protect the openings for ducts and air transfer openings shall be securely attached to or bonded to the construction containing the duct or air transfer opening, without visible openings through or into the cavity of construction. **Any damaged products or materials protecting air transfer openings shall be repaired, restored or replaced.**

2019 NFPA 80

Standard for Fire Doors and Other Opening Protectives

Fire Dampers SHALL be tested (1) year after acceptance testing, every (4) years after that except for buildings containing a hospital which is every (6) years.

- 19.5 Periodic Testing
 - 19.5.1. Testing Frequency
 - 19.5.1.1 Each damper shall be tested and inspected 1 year after acceptance testing
 - 19.5.1.2 The test and inspection frequency shall than be every 4 years, except in buildings containing a hospital, where the frequency shall be every 6 years



2019 NFPA 80

- Testing Procedure includes a visual confirmation of proper operation *(2019 allows for remote inspection if damper is capable and after initial visual inspection)*

19.5.2 Test Method

- Maintenance

19.6.3 If the damper is not operable, repairs shall begin without delay.

2019 NFPA 105

Standard for Smoke Door Assemblies and Other Opening Protectives

Smoke Dampers SHALL be tested (1) year after acceptance testing, every (4) years after that except for buildings containing a hospital which is every (6) years.

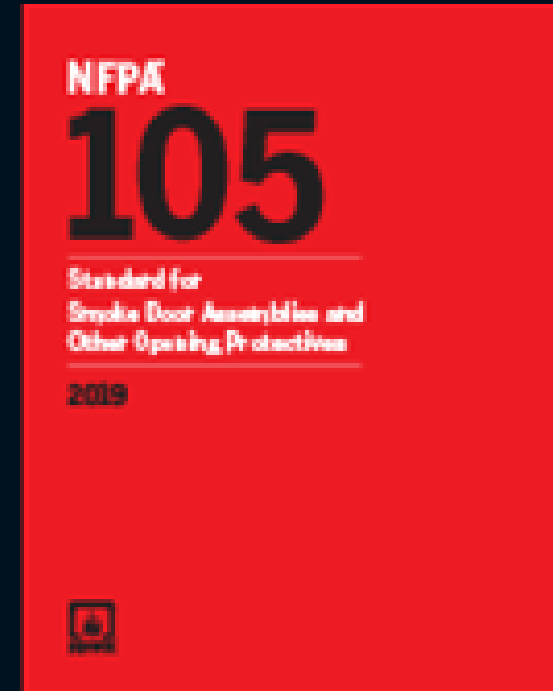

- 7.6.2 Testing Frequency
 - 7.6.2.1 Each Damper shall be tested and inspected 1 year after installation
 - 7.6.2.2 The test inspection shall then be every 4 years, except in buildings containing a hospital, where the frequency shall be every 6 years.
- 7.6.1 General
 - 7.6.1.1 Smoke Dampers for dedicated and nondedicated smoke control systems shall be inspected and tested in accordance with NFPA 92
 - 7.6.1.2 Combination fire/smoke dampers shall be inspected and tested in accordance with NFPA 80.

2019 NFPA 105

- Testing Procedure includes a visual confirmation of proper operation *(2019 allows for remote inspection if damper is capable and after initial visual inspection)*

7.6.3 Test Method

- Maintenance

7.7.3 If the damper is not operable, repairs shall begin as soon as possible.

Smoke Control Systems (SCS)





***“Grenfell Tower’s
smoke ventilation
system failed days
before fire”***

The smoke ventilation system at Grenfell Tower was reported to have failed eight days before the fatal blaze claimed 71 lives, but a proposal to fix it for £1,800 (\$2,329) was ignored, the public inquiry has heard. – The Gaurdian, 180605

Booth also revealed that an earlier proposal for a 12-month maintenance contract involving six-month maintenance visits for the system, costing £3,600 (\$4,659), was ignored. – The Gaurdian, 180605



University of Maryland Study

RELIABILITY OF FIRE DAMPERS, SMOKE DAMPERS AND SMOKE CONTROL SYSTEMS

740 Smoke Control System Projects

Stairwells Requiring repairs or adjustment

- 85% of New Building
- 41% of Existing Buildings Stairwells

Zoned Systems required repairs or adjustment

- 86% of New Building
- 12% of Existing Buildings

Atrium Systems required repairs or adjustment

- 81% of New Building
- 22% of Existing Buildings

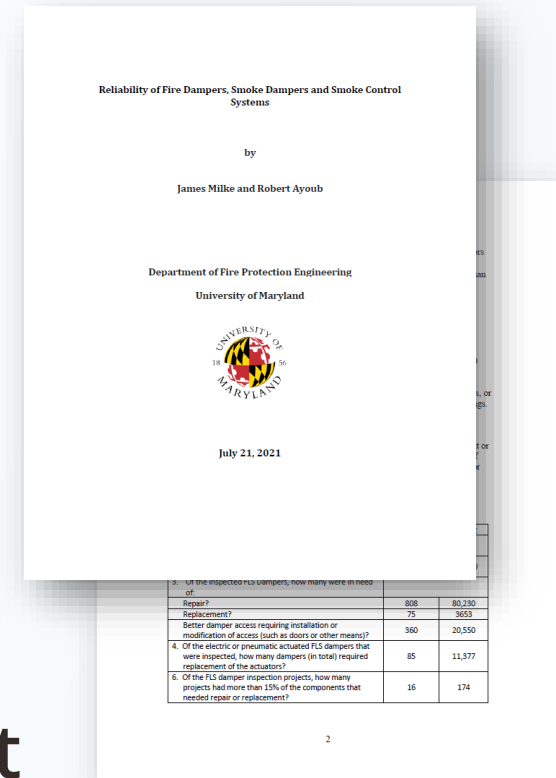

2018 International Fire Code (IFC)



Calls for system being maintained per **Manufacturer's Recommendations**, routine maintenance and operational testing.

- 909.20 Maintenance. Smoke control systems shall be maintained to ensure to a reasonable degree that the system is capable of controlling smoke for the duration required. **The system shall be maintained in accordance with the manufacturer's instructions** and Sections 909.20.1 through 909.20.6.
- 909.20.3 Testing. Operational testing of the smoke control system shall include all equipment such as initiating devices, **fans,** **dampers,** controls, doors, and windows.

2018 NFPA 92

Standard for Smoke Control Systems

Testing Requirements

- 8.3 Periodic Testing
- 8.6.3 The periodic tests shall determine the **airflow quantities** and the **pressure differences** at the following locations:
 1. Across smoke barrier openings
 2. At the air makeup supplies
 3. At smoke exhaust equipment

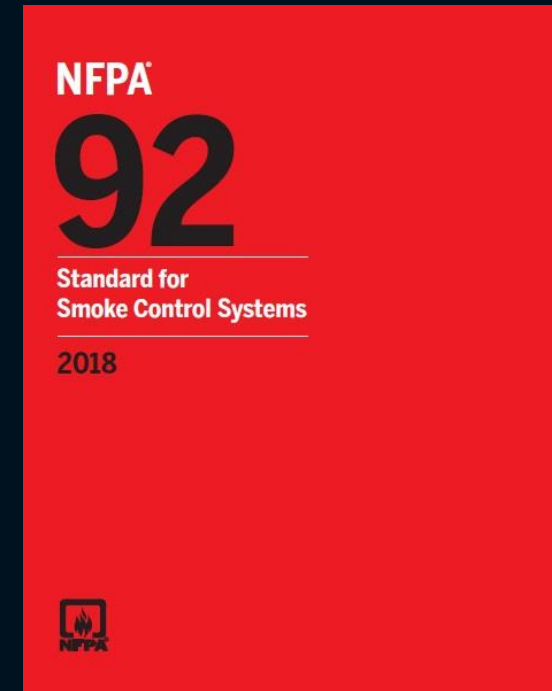

2018 International Fire Code (IFC)

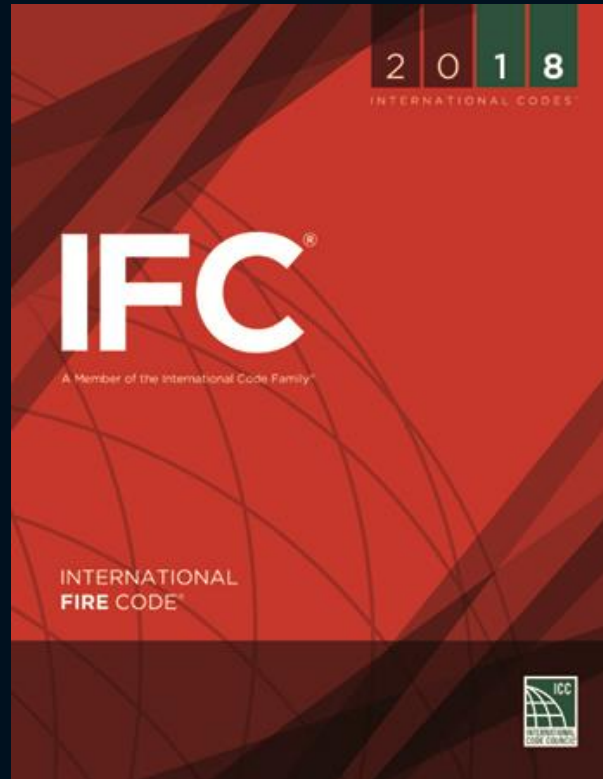

Annual testing of non-dedicated smoke control systems

Semiannual testing of dedicated smoke control systems

- **909.20.4 Dedicated smoke control systems.** **Dedicated** smoke control systems **shall** be operated for each control sequence **semiannually**. The systems shall be tested under standby power.
- **909.20.5 Nondedicated smoke control systems.** **Non-dedicated** smoke control systems **shall** be operated for each control sequence **annually**. The systems shall be tested under standby power.



Quality Control – Need for Workforce Standards



Regional Legislation



- ✓ New Mexico
- ✓ Nevada
- ✓ Washington

WHAT IS THE FIRE & LIFE SAFETY ECOSYSTEM?



The Fire & Life Safety Ecosystem has **8 components**; each plays a critical role in protecting people and property.



International Certification Board (ICB) Certifications

Fire Smoke Damper (FSD)

- ❖ Technician
- ❖ Supervisor
- ❖ Contractor

Smoke Control System (SCS)

- ❖ Technician
- ❖ Supervisor
- ❖ Contractor



Questions??

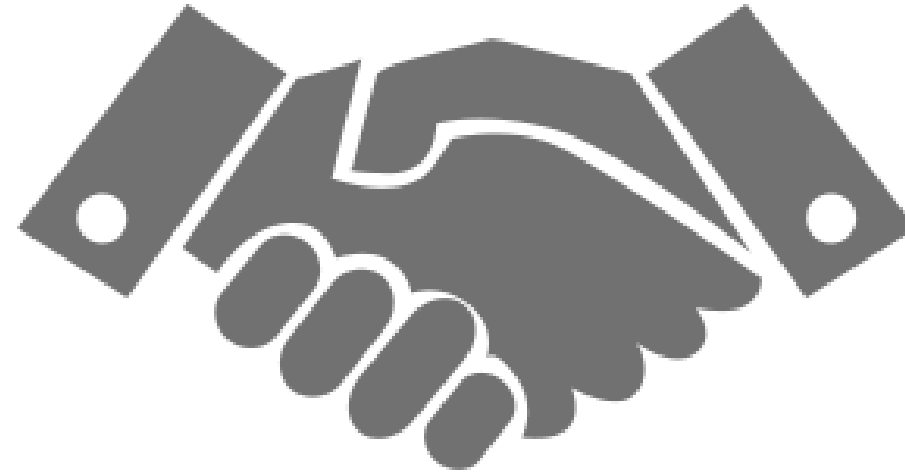

Thank You!