

Oregon State Police

Senate Judiciary Committee





Oregon State Police



The mission of the Oregon State Police is to serve all people with a priority of safeguarding life, property, and natural resources by building upon a diverse, professional, and trustworthy workforce.

We are a diverse agency comprised of 1,502 public safety professionals:

- ▶ 766 police sworn
- ▶ 736 professional staff

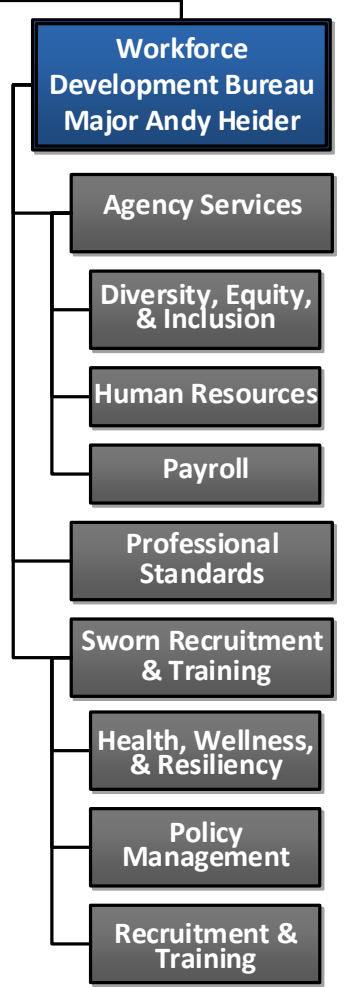
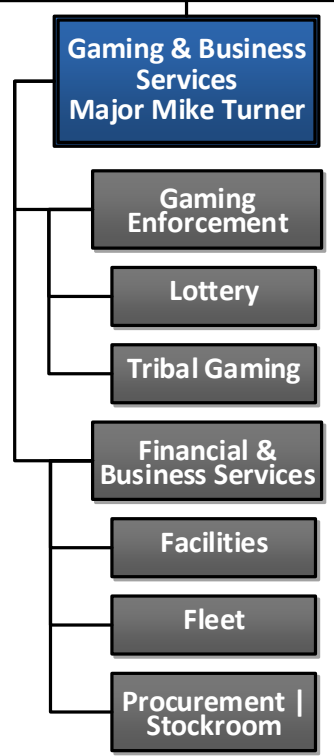
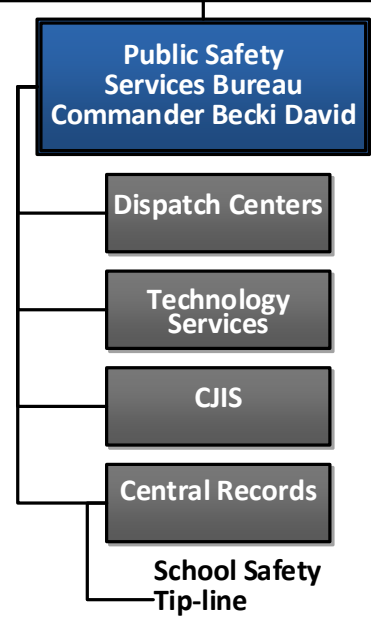
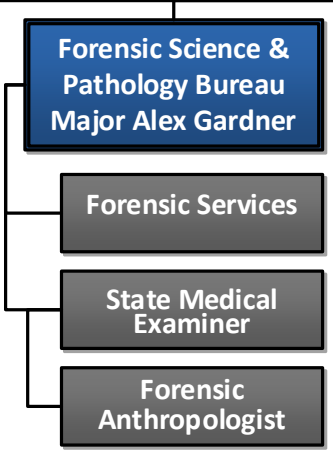
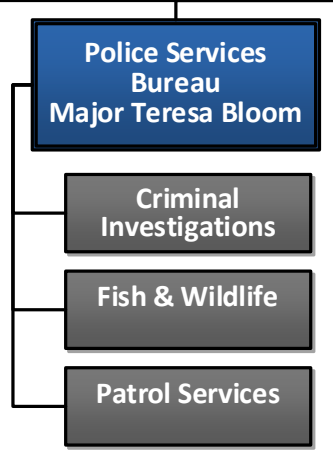
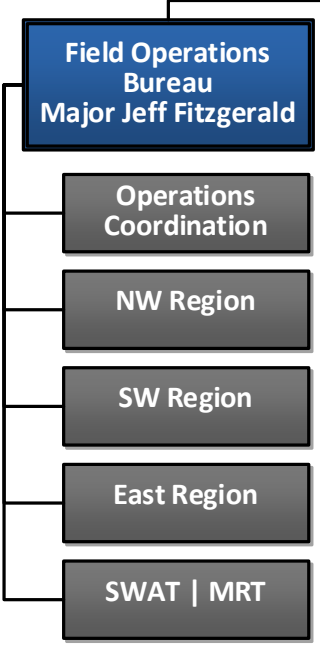
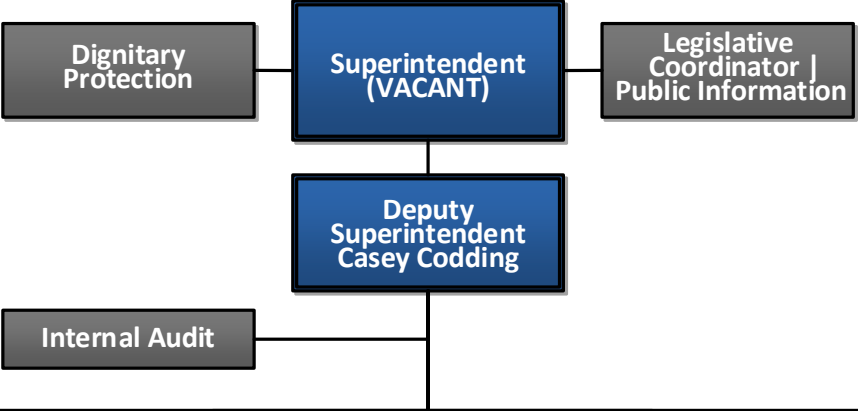



Patrol Services Division



The Patrol Division serves as a rural patrol and provides uniform police services on Oregon's transportation system while assisting local communities and law enforcement.

Patrol Services Division Programs

- ▶ Crash Reconstruction
- ▶ Criminal Apprehension Patrol Enforcement
- ▶ Drug Recognition Expert
- ▶ Impaired Driving
- ▶ Ignition Interlock Device
- ▶ Evidence Program
- ▶ Honor Guard
- ▶ K-9 Program
- ▶ Mobile Response Team
- ▶ SWAT Program
- ▶ Tow Program

Oregon State Police - Traffic/Patrol Division Sworn Staffing Level History vs. Oregon Population (Legislatively Approved/Budgeted)

Sworn Staff Oregon Population (est.)

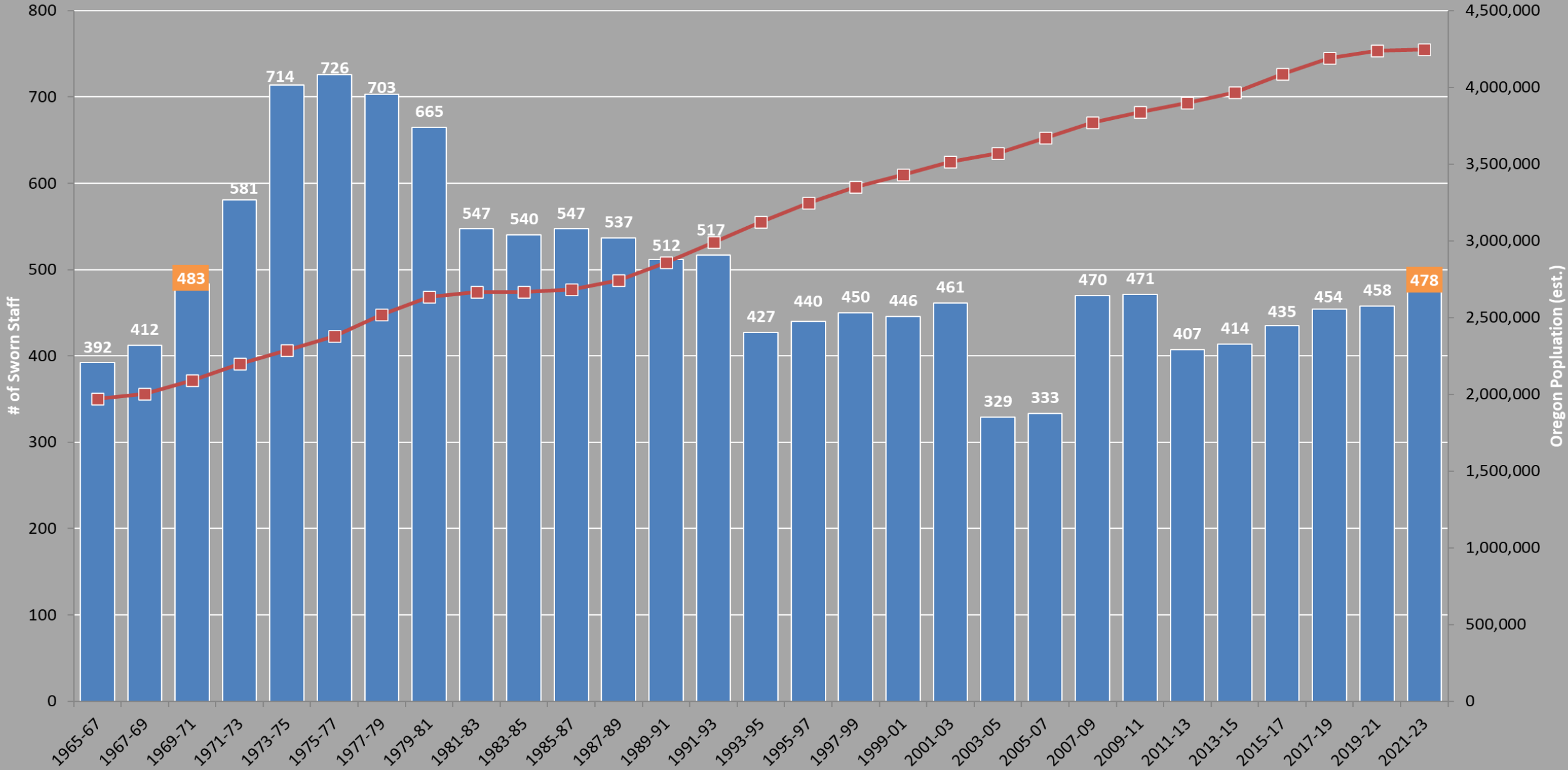

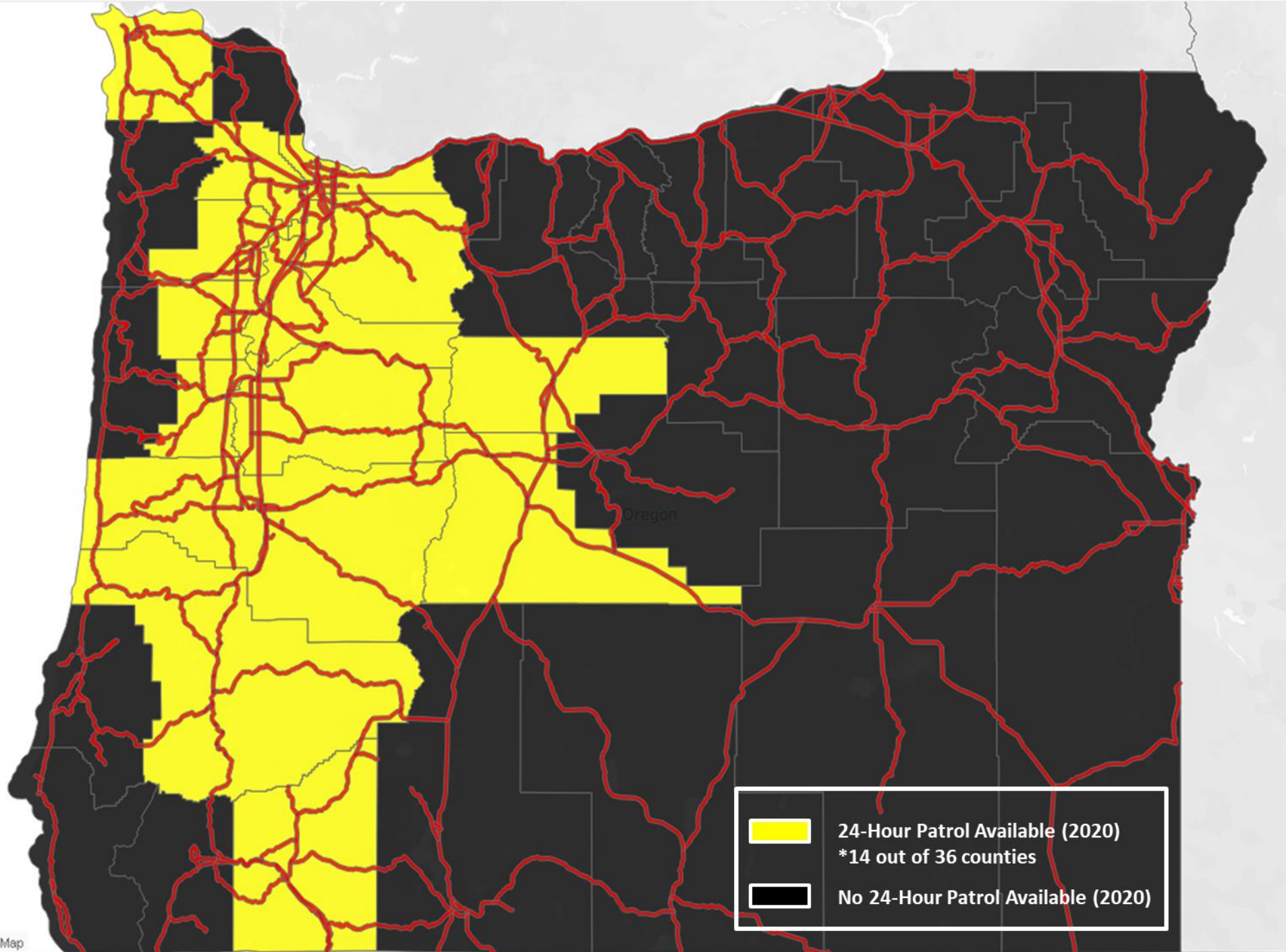



Trooper Vacancies

- ▶ Average Monthly Vacancies = 84
- ▶ Average Monthly Separations = 5 (Troopers + Sergeants)
- ▶ 28 Troopers Eligible to Retire in 2021-23 Biennium (30 additional in 2023-25)

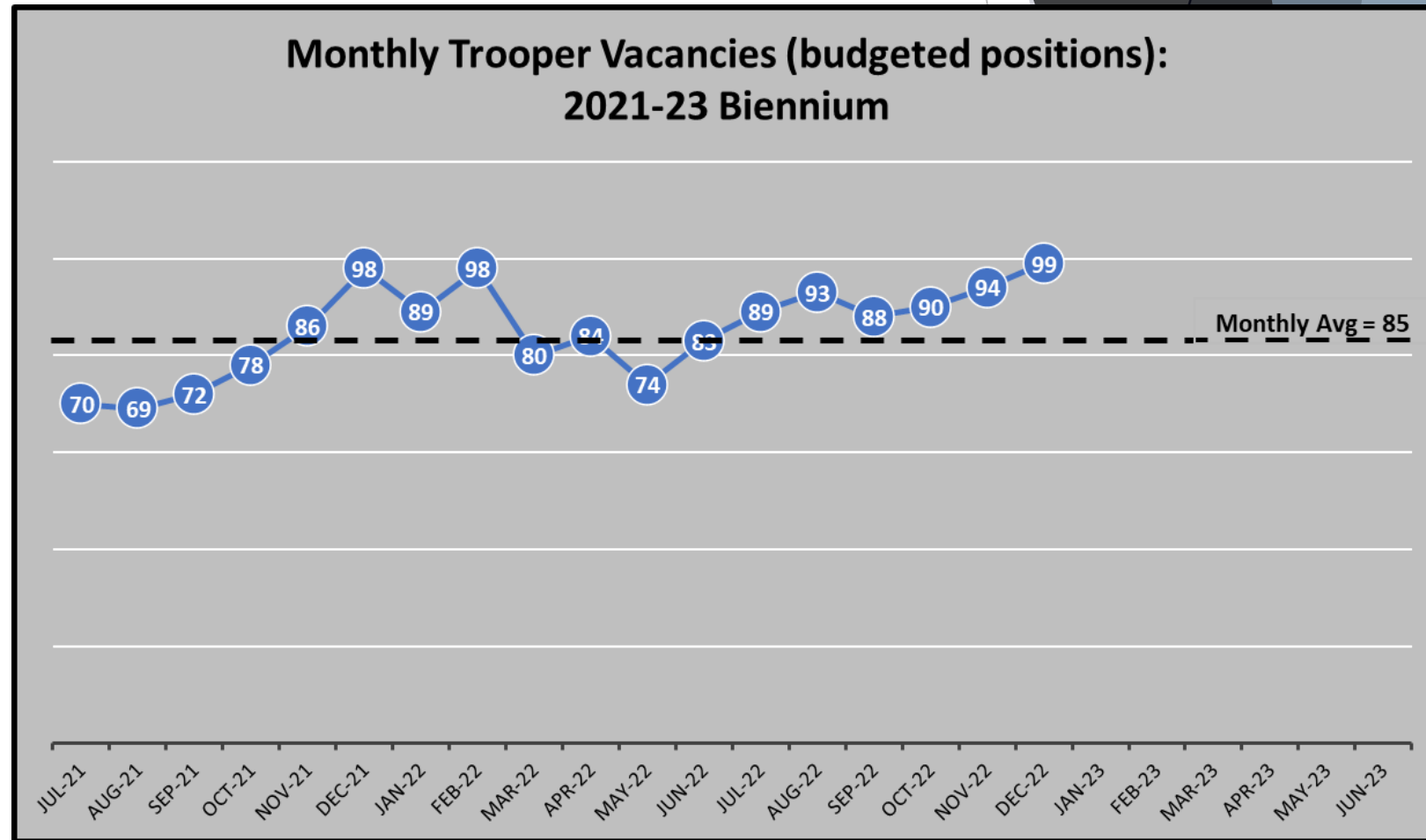

*Based on vacant LAB positions as of 12/31/2022.



Operational Impact

- ▶ Trooper preventive enforcement efforts are not able to be sustained.
 - ▶ Low officer availability
 - ▶ Minimal staffing numbers
 - ▶ Vacancies
- ▶ Oregon's fatality rate is now trending above the national rate.
 - ▶ Speed
 - ▶ DUII-related
 - ▶ Oregon is above the national rate
 - ▶ Traffic accidents leading cause of death in Oregon for people aged 1-24, in the combined years 2001-2020 (CDC, WISQARS database).

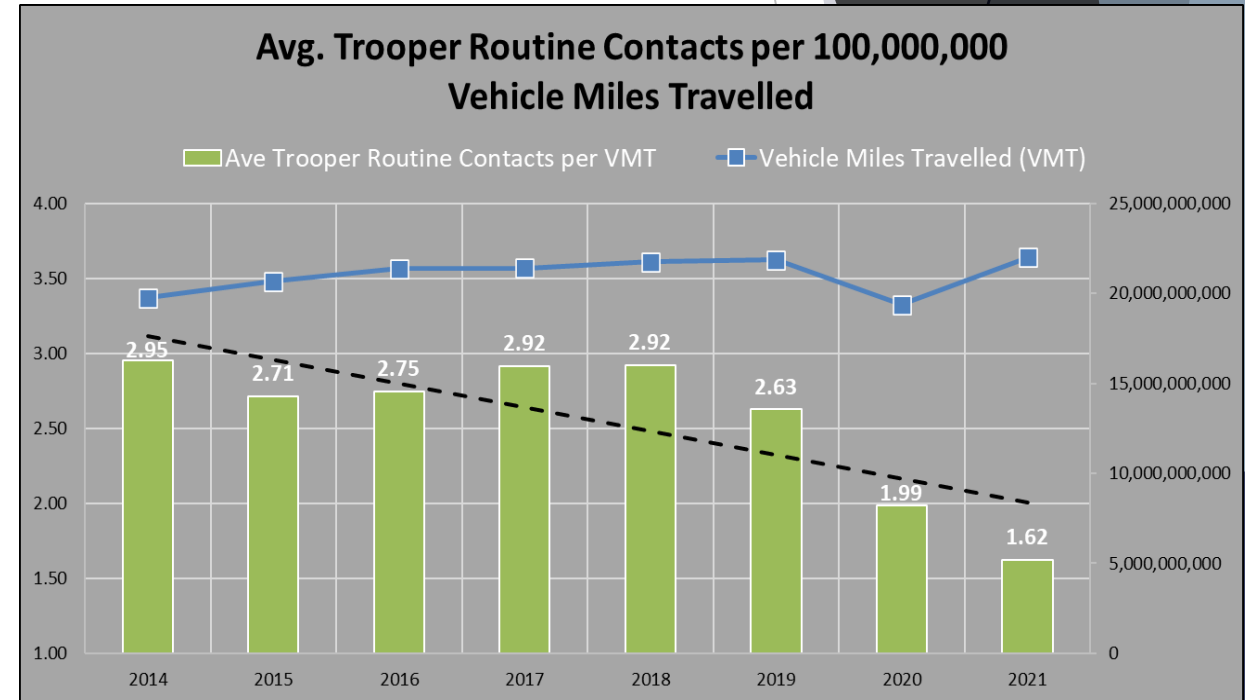



Fish and Wildlife Division



The Fish and Wildlife Division ensures sustainable fish and wildlife resources and protects environmental and cultural assets.

Fish and Wildlife Division Programs

- ▶ Aviation Unit
- ▶ K-9 Unit
- ▶ Marine Fisheries Team
- ▶ Special Investigations Unit
- ▶ Wildlife Enforcement Decoy Program
- ▶ Wildlife and Fisheries Section



Criminal Investigation Division



The Criminal Division provides investigative support and assistance to OSP divisions, state agencies, and local law enforcement.

Criminal Investigation Division Programs

- ▶ Arson
- ▶ Drug Enforcement
- ▶ Explosives
- ▶ Homicide Investigation Tracking System
- ▶ Missing Person Clearinghouse
- ▶ Investigative Support Unit
- ▶ Major Crimes
- ▶ Digital Forensic Unit



Lottery Security Section



The Lottery Security Section provides dedicated investigative and regulatory support to the Oregon State Lottery to ensure and oversee all physical, logical, and regulatory security related to the lottery's retailer network and its state-operated lottery games.

Lottery Security Priorities

- ▶ Retailer Background Checks
- ▶ Regulatory Compliance
- ▶ Criminal Investigations
- ▶ Winning Ticket Security Requirements



Tribal Gaming Section



Ensure that all Class 3 Tribal Gaming activities are conducted with Fairness, Integrity, Security, and Honesty.

Tribal Gaming Priorities

- ▶ Compact Compliance Requirements
- ▶ Class III Gaming Accounting, Auditing, and Reporting
- ▶ Gaming Facilities Surveillance and Security
- ▶ Gaming Integrity
- ▶ Controls for Sensitive Items
- ▶ Game Technology and Networks



Oregon State Athletic Commission



The Commission, through the Administrator, regulates all unarmed combat sports and entertainment wrestling including licensing, medical clearance, officials' training and direction, event regulation, and other regulatory duties.

OSAC Priorities

- ▶ Regulatory Monitoring of Unarmed Combat Sports
- ▶ Regulatory Monitoring of Entertainment Wrestling
- ▶ Promote Health and Safety Best Practices



Forensic Services Division

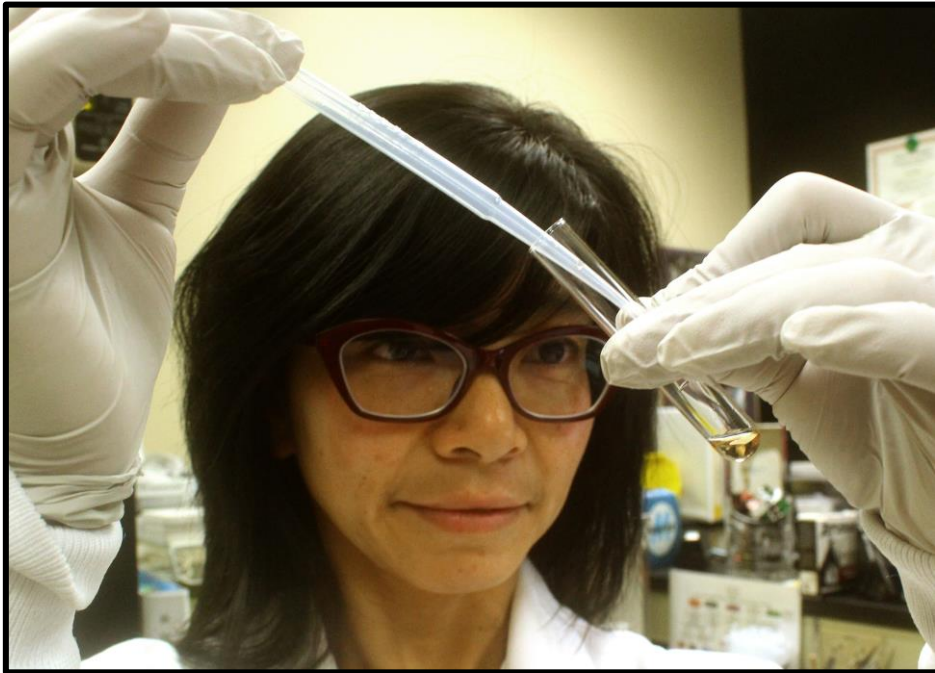

The Forensic Services Division is the sole provider of most forensic science services in Oregon and seeks to provide timely and accurate scientific, technical, and investigative services in support of the criminal justice system.

Forensic Services Division Programs

- ▶ Biology Processing
- ▶ Drug Chemistry
- ▶ Crime Scene Investigation
- ▶ DNA | CODIS
- ▶ Firearms | Tool Marks
- ▶ Implied Consent Program
- ▶ Latent Prints
- ▶ Toxicology | Blood Alcohol
- ▶ Trace Evidence



State Medical Examiner



The Oregon State Medical Examiner's Office is the sole provider of forensic pathology services in Oregon and seeks to provide professional, timely, consistent, and compassionate death investigation services.

State Medical Examiner Responsibilities

- ▶ Death Certification
- ▶ Court Testimony
- ▶ Consultation
- ▶ Child Fatality Reviews
- ▶ Mass Fatality Planning
- ▶ Informing the public health
- ▶ Communication with families
- ▶ Coordination with organ procurement organizations
- ▶ Postmortem Examinations (Autopsies)



Criminal Justice Information Services (CJIS)

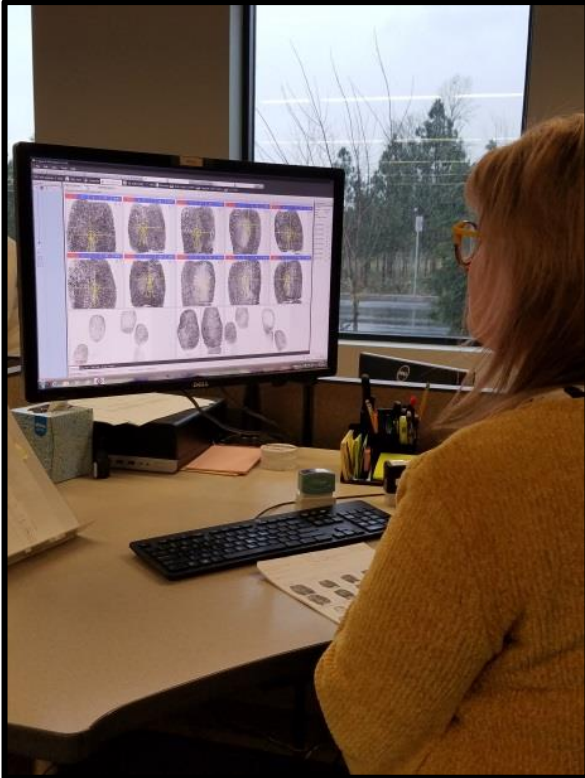

The CJIS Division is Oregon's sole-source repository for statewide criminal offender information and the exchange of law enforcement/criminal justice records nationally.

CJIS Services

- ▶ Automated Biometric Information Systems
- ▶ Computerized Criminal History
- ▶ Firearms Instant Check System
- ▶ Law Enforcement Data Systems
- ▶ Permit-to-Purchase Unit (BM 114)
- ▶ Regulatory Background Unit
- ▶ Sex Offender Registration



Recruiting and Retention

- ▶ Diversity, Equity, and Inclusion (DEI) Unit
 - ▶ Recruiting
 - ▶ Policy Review
 - ▶ Training Development
- ▶ Health, Wellness, and Resiliency (HWR) Unit
 - ▶ Employee Engagement
 - ▶ Holistic Health and Wellness Resources
 - ▶ Employee Satisfaction
 - ▶ Retention
 - ▶ Availability





OSP Legislative Contacts



Deputy Superintendent Casey Coddling
Casey.Coddling@osp.oregon.gov



Captain Kyle Kennedy
Kyle.Kennedy@osp.oregon.gov