

January 2022

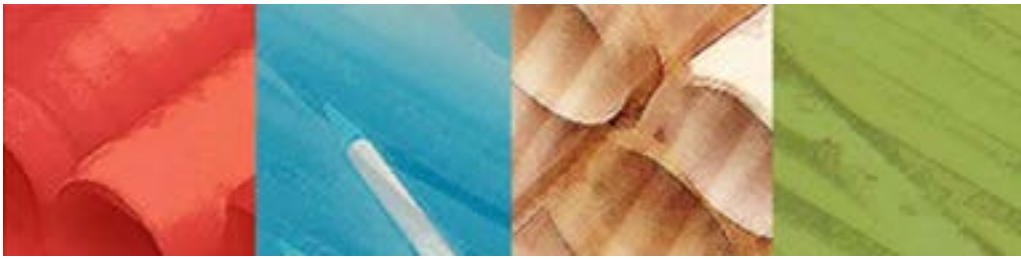

# **BEHAVIORAL HEALTH DESIGN GUIDE**

*Formerly:*

Design Guide for the Built Environment  
of Behavioral Health Facilities

**Kimberly N. McMurray, AIA, EDAC, NCARB, MBA**

*Founders and Authors Emeritus:*

James M. Hunt, AIA

David M. Sine, DrBE, CSP, ARM, CPHRM

**Behavioral Health Facility Consulting, LLC**

Previously Published by:

National Association of Psychiatric Health Systems (NAPHS) 2003-2014

Facility Guidelines Institute (FGI) 2015-2017

# Contents

Introduction . . . . .	4
A Word from the Author. . . . .	5
Resources. . . . .	6
More Information on Specific Topics . . . . .	7
Glossary . . . . .	7
A Word from BHFC Design. . . . .	8
General Comments. . . . .	9
A. Space Planning Considerations.....	9
B. Safety.....	12
Construction and Materials Considerations . . . .	15
A. Baseline considerations for patient areas.....	15
B. Level I.....	42
C. Level II.....	43
D. Level III.....	48
E. Level IV.....	51
Level IV-a. Patient Rooms . . . . .	51
Level IV-b. En-suite Patient Toilet Rooms: . . . . .	61
F. Level V: . . . . .	71
Level V-a. Admissions: . . . . .	71
Level V-b. Seclusion Rooms and Restraint Rooms . . . . .	74
Summary . . . . .	79
Appendix Index. . . . .	A1
About the Author. . . . .	A80
List of Manufacturers . . . . .	A81

# Behavioral Health Design Guide

January 2022

© 2022 Behavioral Health Facility Consulting, LLC

In an effort to keep up with the rapid increase in the number of products available for use in behavioral and mental health facilities, our website products section will be frequently updated and the Behavioral Health Design Guide document will be updated on an annual basis. The date of each edition is on the cover and at the top of each page of the document.

Readers are urged to check: [www.bhfcllc.com](http://www.bhfcllc.com) whenever referring to this document to assure the latest information is being accessed.

For direct contact information: [kimberly@bhfcllc.com](mailto:kimberly@bhfcllc.com) , Kimberly McMurray at 205-454-2210.

## November 2019 Edition

The November 2019 edition was extensively reorganized from the previous editions of 2003 through 2018. The major difference is the inclusion of the “*Baseline Considerations*” section. This is intended to simplify and clarify the differences between the various Levels of Risk introduced in the Safety section discussion. The Section for each risk level addresses how that Level differs from the Baseline Considerations.

*This document is intended to represent leading current practices, in the opinion of the authors. It does not represent minimum acceptable conditions or establish a legal “standard of care” that facilities are required to follow.*

## Introduction

This document is intended to address the built environment of the general adult inpatient behavioral health care unit. Additional considerations that are not addressed here are required for child and adolescent patients, patients with medical care needs, dementia patients, and some patients with diagnoses such as substance abuse and eating disorders.

This document is not a replacement for regulatory requirements, but rather augments them to detail practical means of protecting patients and staff. It is intended to represent leading current industry practices, in the opinion of the authors. It is not intended to represent minimum acceptable conditions and should not be interpreted as establishing a legal “standard of care” that facilities are required to follow.

**Please Note:** Product information included in this document is intended for illustration of one or more specific items that are deemed appropriate for use in this type of facility. Comparable products by other manufacturers that meet the same design criteria may be substituted after careful comparison.

As in earlier editions, we have highlighted products we have found to be more safe and able to withstand the rigors of use in the behavioral health care environment. However, inclusion or exclusion of a product does not indicate endorsement or disapproval of that product, nor does it suggest that any product we identify is free of risk. As well, there may be equivalent products available; all facilities should continually look to the marketplace to find products that are safer and more cost-effective.

**Please Note:** *The 2022 Edition of the FGI Guidelines for Design and Construction of Hospitals, Outpatient Facilities and Residential Health (3 volume) publication will be available in April 2022. There are significant changes to the Behavioral and Mental Health sections of the FGI Guidelines, especially in the emergency services section, that may influence some revisions to the Behavioral Health Design Guide. We will review and offer any significant updates during 2022 through our BHFC website. The 2023 edition of the Behavioral Health Design Guide will incorporate relevant FGI 2022 edition items that may need to be revised within our Design Guide. Thank you.*

## A Word from the Author

This Behavioral Health Design Guide is authored by Kimberly N. McMurray, AIA, EDAC, NCARB, MBA, Principal of Behavioral Health Facility Consulting, LLC (BHFC Design). Founders and executive authors are James M. Hunt, AIA, Founder and Retired Senior Consultant of Behavioral Health Facility Consulting, LLC; and David M. Sine, DrBE, ARM, CSP, CPHRM, president of SafetyLogic Systems.

Kimberly McMurray, as practice leader for BHFC Design, brings an architectural career dedicated to healthcare design, including a period of being on staff at a major academic medical center. McMurray is currently immersed in the daily contact with Behavioral and Mental Health organizations and designers engaged in the process of navigating through today's complex behavioral health environments. BHFC Design involvement with projects and behavioral health organizations range from standalone Crisis Response Centers, Behavioral Health Emergency Services, Inpatient Services, Diagnostic Treatment to Outpatient Services for a range of patient and client populations.

The writing of the Behavioral Health Design Guide is based on our experiences in the field as operators, designers, consultants, and surveyors. Our goal is to share what we have seen that is working and what we have seen that has not worked. Since the document was first electronically published by the National Association of Psychiatric Health Systems (NAPHS), now National Association for Behavioral Healthcare (NABH), in 2003 we have received and welcomed countless suggestions, recommendations, and comments from users of the Design Guide, which continue to inform and lead us to new discoveries. We are grateful and humbled by how well our suggestions have been received and that they have inspired others to think of new solutions to the inherent challenges of the mental and behavioral health built environment.

We hope this edition of the Behavioral Health Design Guide (formerly the Design Guide for the Built Environment of Behavioral Health Facilities) will meet the expectations of and prove useful to the operators, clinicians and designers who are entrusted with both the care of behavioral health patients and with the environment of care in which those people are cared for and treated. For this point forward in this document, we will refer to the Behavioral Health Design Guide as simply the "**Design Guide**".

As always, we introduce this edition with the same reminder we used to introduce the inaugural edition in 2003: *"While a safe environment is critical, no environment of care can be totally safe and free of risk. No built environment—no matter how well designed and constructed—can be relied upon as an absolute preventive measure. Staff awareness of their environment, the latent risks of that environment, and the behavioral characteristics and needs of the patients served in that environment are absolute necessities. We also know that different organizations and different patient populations will require greater or lesser tolerance for risk; an environment for one patient population will not be appropriate for another. Each organization should continually visit and revisit their tolerance for risk and changes in the dynamics of the patient population served."*

Thank you,

**Kimberly N. McMurray, AIA, EDAC, NCARB, MBA** [kimberly@bhfc LLC.com](mailto:kimberly@bhfc LLC.com)

*This document is intended to represent leading current practices, in the opinion of the authors. It does not represent minimum acceptable conditions or establish a legal "standard of care" that facilities are required to follow.*

## Resources

**ADA - Americans with Disabilities Act.** The Americans with Disabilities Act gives civil rights protections to individuals with disabilities similar to those provided to individuals on the basis of race, color, sex, national origin, age, and religion. It guarantees equal opportunity for individuals with disabilities in public accommodations, employment, transportation, state and local government services, and telecommunications. See [www.ada.gov](http://www.ada.gov).

**CMS - Centers for Medicare & Medicaid Services.** CMS is part of the U.S. Department of Health and Human Services and is responsible for the administration of the Medicare and Medicaid programs. They are currently finalizing their proposed “Clarification of Ligature Risk Interpretive Guidelines”. Text of the draft is available [on their website](#) and at [www.bhfclic.com](http://www.bhfclic.com).

**FGI Guidelines - FGI Guidelines for Design and Construction of Hospitals.** Published by the Facility Guidelines Institute and is adopted as law by some states and used by some courts as establishing a Standard of Care. Verify edition that may be adopted at any specific location with local Authorities Having Jurisdiction (AHJ). The authors recommend complying with the latest published edition (2018 at the time of this publication) for all projects. This volume includes chapters on free-standing psychiatric hospitals and psychiatric units in general hospitals. Other volumes are available for Outpatient Facilities and Residential Health Care and Support Facilities. For information on purchasing the FGI Guidelines, visit [www.fgiguidelines.org](http://www.fgiguidelines.org).

**HIPAA - Health Insurance Portability and Accountability Act, 1996.** The Office for Civil Rights in the U.S. Department of Health and Human Services (HHS) enforces the HIPAA Privacy Rule, which protects the privacy of individually identifiable health information; the HIPAA Security Rule, which sets national standards for the security of electronic protected health information; and the confidentiality provisions of the Patient Safety Rule, which protect identifiable information being used to analyze patient safety events and improve patient safety. See [www.hhs.gov/ocr/privacy](http://www.hhs.gov/ocr/privacy).

**IAHSS - International Association for Healthcare Security and Safety**  
They publish security recommendations for many types of facilities, including behavioral health.  
See [www.iahss.org](http://www.iahss.org)

**NFPA - National Fire Protection Association.** They publish the NFPA 101: Life Safety Code®, and many other applicable codes and regulations. For more on NFPA or links to new publications, see [www.NFPA.org](http://www.NFPA.org).

**NIC - National Institute of Corrections.** Some of their standards may be applicable to behavioral health facilities, especially those regarding air grilles. See [www.nicic.gov](http://www.nicic.gov).

**TJC - The Joint Commission.** There is now free access to a Suicide Prevention Portal on [TJC's website](#). This contains the recommendations of TJC's Expert Panel on Suicide Prevention, related National Patient Safety Goals discussion regarding tools for evaluating the suicidal intention of patients. This is kept updated with the latest information and is available to all without a subscription fee.

*This document is intended to represent leading current practices, in the opinion of the authors. It does not represent minimum acceptable conditions or establish a legal “standard of care” that facilities are required to follow.*

## More Information on Specific Topics

- **GLAZING: Syroka & Associates, Inc.**  
Bob Syroka, CSI - President ([www.syrokaandassociates.com](http://www.syrokaandassociates.com))
- **HOSPITAL SECURITY: Healthcare Security Consultants, Inc.**  
Thomas A. Smith, CHPA, CPP - President ([www.healthcaresecurityconsultants.com](http://www.healthcaresecurityconsultants.com))

## Glossary

- **Ligature-Resistant:** The Joint Commission (TJC), in its November 2017 Edition of its *Perspectives* newsletter recommends the term “Ligature-Resistant” over “Ligature-Free” because it is not possible to remove all potential ligature risk points that could be used in a suicide attempt. It defines Ligature-Resistant as, “***Without points where a cord, rope, bed-sheet, or other fabric/material can be looped or tied to create a substantial point of attachment that may result in self-harm or loss of life.***”
- **Tamper-Resistant:** For the purposes of this document, the authors use the term “tamper-resistant” to refer to items that are difficult for patients to remove or damage using items to which they typically have access.
- **Safety Risk Assessment:** The *FGI Guidelines for the Design and Construction of Hospitals* (2018 Edition) **Section 1.2-4 Safety Risk Assessment (SRA)** requires that such an assessment, including **Section 1.2-4.6 Behavioral and Mental Health Risk (Psychiatric Patient Injury and Suicide Prevention) Assessment** as described therein be performed for all such facilities.

## A Word from BHFC Design

The **Behavioral Health Design Guide** (Design Guide) addresses the built environment for adult inpatient mental and behavioral health care units and the evolving Design Guide was moved from its former home with the Facilities Guidelines Institute or FGI to its present home on the Behavioral Health Facility Consulting, LLC (BHFC) website, [www.bhfcllc.com](http://www.bhfcllc.com) in 2018. We found this move necessary in order to preserve the independence of the Design Guide and, through affiliate relationships, to provide even more organizations and their members access to a document that addresses leading practice design challenges of the built environment for adult inpatient behavioral health care units.

Some of the elements of the Design Guide, such as the **Environmental Safety Risk Assessment tool**, will continue to appear in the FGI Guidelines for Design and Construction of Hospitals and Outpatient Facilities. This Design Guide provides much more detail and leading practices for protecting patients and staff as identified through the authors' years of practice in the field. The Design Guide is not intended as a replacement for regulatory requirements nor to be employed as a legal "standard of care." Its content is provided to augment the fundamental design requirements for behavioral and mental health facilities and to help providers and design teams develop physical environments that support safe and effective behavioral and mental health services.

As stated in the introduction, we should remind readers that the Design Guide does not discuss the additional concerns that must be addressed when designing behavioral and mental health facilities for child and adolescent patients, patients with medical care needs, geriatric patients, or some patients with diagnoses such as substance abuse and eating disorders. These specialty population needs will be addressed in future editions of the Design Guide and the white papers will be posted on our website at [www.bhfcllc.com](http://www.bhfcllc.com).

The **Appendix** contains information about products that have been found to be more safe for use in the behavioral and mental health built environment but is in no way a complete list of products available that may be appropriate, while recognizing that no product is entirely without risk. We should also point out that the editors vigorously resist offers to monetize the Design Guide or be compensated by enthusiastic vendors.

The Design Guide is updated annually, and while we trust you will find the latest changes helpful, our goal is to provide updates more frequently through the products section on our website; so please return to our website occasionally to make sure you are referring to the most current Design Guide edition and referencing the latest products.

Thank you for your continued interest in and use of the Behavioral Health Design Guide.

**Kimberly N, McMurray, AIA, EDAC, NCARB, MBA – Principal**



## General Comments

### A. Space Planning Considerations

Behavioral and mental health units and facilities are preferred to be designed to appear comfortable, attractive, relaxing and as residential in character as possible. The focus on patient and staff safety has often pushed the aesthetics of these units toward the appearance of a prison environment. To better meet the needs of patients, the final design must avoid an “institutional look” while meeting the array of applicable codes and regulations and addressing the therapeutic and safety needs of patients and staff. These no longer need to be either-or trade-offs. Both safety and therapeutic environment are possible in a well-designed facility that has a non-institutional appearance that is correct for the unique conditions that exist in each facility.

1. The **FGI Guidelines** Section 1.2-4 requires that a Safety Risk Assessment (SRA) be performed to determine the level of risk that is acceptable for both patients and staff in each part of the patient accessible areas of behavioral health units. The SRA Report is vital and must be consulted in reaching all safety related decisions. Refer to the *Environmental Risk Assessment* methodology, ‘Section B’ described in the Design Guide for further discussion and assistance with the development of a SRA.
2. Nurse station designs are preferred to provide the least acceptable barrier between staff and patients. This goal may conflict with staff safety concerns as patients may be able to reach or jump over counters. Some facilities have found ways to design nurse stations that protect against these actions without discouraging conversation and exchange of objects between staff and patients (**See photos at right, note fine vertical lines in the Enclosed photo**). When minimal physical barriers are provided, it is often desirable to include a conveniently located lockable door through which staff can retreat when feeling threatened. **HIPAA** privacy regulations can make use of an “open” design challenging because patient records, electronic or otherwise, must be protected from view by other patients, visitors, and unauthorized staff. However, advancements in electronic medical records have somewhat reduced the need to locate all charting-related activities and spaces in the area behind the nurse station. Since the electronic “chart” can be accessed from many locations, the area around the nurse station can often be used for more patient-centered activities. When a more open nurse station is achieved, other areas where clinical staff can discuss patients without being overheard is needed.
3. Location of gathering areas for patients near the nurse station is encouraged because patients often congregate by the nurse station to socialize. It is far better to plan for this behavior and accommodate it in the original design. Such gathering areas should include comfortable seating and places for conversation, card or board games, and other quiet activities that will not distract staff working in the nurse station. Television



**ENCLOSED**

sets and other electronic entertainment equipment is not preferred in these locations. Many facilities are now experiencing issues, especially with younger patient populations, regarding use of personal electronic devices (e.g., iPods, MP-3 players, and similar devices). Patients say these electronics help keep them calm. Wireless earphones are strongly suggested because wires on the earphones can be hazardous.

4. Chart rooms, heads down focused task and other staff areas should be located so staff members can have conversations and make phone calls regarding patients and other clinical matters without being overheard by patients or visitors. Teaching hospitals that have a large number of residents and/or students making rounds will need larger spaces for confidential conversations. The expanded use of electronic medical record technology is continuing to change the needs and configurations of these spaces.
5. Facilities for medication distribution should support the organization's practices but allow for flexibility. Medication management has evolved over the years from patients lining up at a window at designated times to staff taking medications to patients wherever they are on the unit. While the trend is strongly toward the latter, some facilities prefer the former or some variation of the two. This practice should be clearly defined in every facility's functional program and Environmental Safety Risk Assessment. Flexibility should be designed into the built environment to allow for future changes in how this critical function is provided. Medication rooms and/or zones should also be provided in accordance with the requirements of the **FGI Guidelines** and all other applicable codes, standards and regulations.
6. Where possible, locate service areas (such as trash rooms and clean and soiled utility rooms) so they are accessible from both the unit and a service corridor. This eliminates the need for environmental staff servicing these rooms to enter the treatment areas of the unit and possibly disturb patient activities. All doors to these rooms must be kept locked at all times.
7. Traditional nurse call systems for patients to request assistance from nursing staff are not required in behavioral and mental health units by the **FGI Guidelines**. Significant new developments in duress alarm systems greatly improve safety for staff who find themselves threatened by patients. Sensors located in all patient-accessible areas are activated using a small device that the staff members wear.<sup>650</sup> Staff may activate the alarm when they feel threatened and want other staff to come. Different alarm products announce in different ways, but many provide the exact location of the staff member activating the alarm.
8. All electrical outlets in patient rooms are required by the **FGI Guidelines** to be tamper-resistant, hospital-grade units on arc-fault interrupted circuits. The breakers for these circuits should be located so staff can easily access them without entering patient rooms. This is easy to accomplish in new construction but can be very difficult to achieve in remodeling projects. If receptacles with individual reset buttons are provided, they should be wired so that activation of one receptacle's breaker does not deactivate the entire circuit.

9. Where possible, locate water shut-off valves for patient accessible bathrooms in corridor walls so they can be accessed from the corridor by opening a locked access door. This has been successfully accomplished during remodeling projects of existing units, as well as new construction projects.
10. Where possible, locate serviceable parts of patient room HVAC systems where they can be serviced without entering the room. In new construction, consideration may be given to radiant heating and cooling systems that greatly reduce the need for mechanical devices in patient rooms.
11. Housekeeping rooms should be large enough to lock away carts when not in use. All cleaning materials must be locked inside these carts at all times when carts are in patient areas or corridors and not attended by staff.
12. Smoking areas (if provided) should be outdoors. Furniture should be securely anchored in place. Provision should be made for staff observation without having to breathe secondhand smoke. No wastebaskets should be allowed in these areas. Indoor smoking is not permitted in most facilities, and many hospitals now have smoke-free campuses.
13. At the time of this writing, the **FGI Guidelines** require patient bedrooms to have a minimum clear floor area of: 100 square feet for single-patient room; and 80 square feet for multiple-patient rooms (Section 2.5-2.2.2.2). FGI indicates the maximum capacity shall be two patients (Section 2.502.2.2.1).

Recent interpretations by FGI indicate the space under the fixed platform bed should be included within the calculation for clear floor area for behavioral and mental health facilities; based upon the significant differences with the function of the patient room in behavioral health as compared to medical and surgical patient rooms. The behavioral and mental health environment, clinical care generally does not occur inside the patient room. Behavioral and mental health patient bedrooms are designed for safety, sleeping and hygiene.

All requirements of these **FGI Guidelines**, the latest adopted editions of **NFPA 101: Life Safety Code®**, applicable building codes, engineering codes, local AHJs regulations and other codes as applicable, should be reviewed and carefully followed.

14. The concept of “*On-Stage*” and “*Off-Stage*” is widely adopted within medical healthcare facilities and is an emerging consideration for the design of behavioral and mental health facilities, especially in response to the pandemic to limit direct support staff and patient exposures. This concept separates, where possible, patient pathways (on-stage) throughout the facility from materials management food service, clean materials delivery within the facility, as well as staff support areas (off-stage). This separation of support services minimizes noise, disruption, distractions, and patient’s exposure to potential elements that if accessed by the patient could be a safety risk – exposing these elements into areas actively used by patients.

15. Technology and Telehealth Resources in mental and behavioral health setting has significantly increased in both inpatient and outpatient facilities enhancing security, communications, safety (both physical and from limiting exposure to airborne viruses) and patient care. Security enhancements for technology include door control, inventory control, facility monitoring and integration of physiological reporting. Health records and multidisciplinary health team communications include access to continually updated patient records and collaboration by all appropriate members of a patient's interdisciplinary care team; and emerging tele-mental health refers to remote visual/audio communication between the patient and care team professionals. We are currently working with organizations where auxiliary services such as pharmacy are using telehealth resources to meet with patients rather than in person, even when these resources are physically located on campus.

## B. Safety

**Safety for both patients and staff is a primary concern for all behavioral and mental health facilities.**

The level of concern for how the design of the built environment affects the safety of patients and staff is not the same in all parts of a behavioral health unit or facility. The level of precautions necessary depends on the staff's knowledge of the patient's intentions regarding self-harm and the amount of supervision the patient will have while using that part of the facility. Previous editions of this Design Guide have proposed that the level of concern for patient safety in the behavioral health built environment can be separated into five categories (with five being the highest level of concern). The concept is that areas that patients do not enter can be designed similar to other hospitals. Areas that patients will enter have some latitude in design, construction, and what materials can be allowed. The lowest patient accessible areas are spaces that are behind self-closing, self-locking doors and where staff are always present with patients. Much stricter requirements need to be met for areas where patients will be alone for long periods of time with minimal supervision.

These levels are discussed in detail below and illustrated by Exhibit One ***Environmental Safety Risk Assessment*** matrix. Additional discussion and review of this concept of the five risk level system has been confirmed by independent and peer-reviewed research (Bayramzadeh, S, *Health Environments Research & Design Journal* 2017, Vol.10(2) 66-80). A link to this independent research paper can be accessed through our website at [www.bhfcllc.com](http://www.bhfcllc.com).

Many organizations have adopted this approach of assessing levels of concern based on a functional statement of intended use and have agreed on the level of risk for rooms or spaces with similar occupant functions. However, caution is necessary as some rooms or room functions can fit comfortably into more than one category or sit on a blurry boundary between two categories. As well, the categories do not always anticipate every use of every room. This blurry boundary can result in clinical staff and facility designers basing design choices on assumptions about the use of a room and its corresponding level of concern that may not meet the actual needs of the stakeholders in an operating environment.

*This document is intended to represent leading current practices, in the opinion of the authors. It does not represent minimum acceptable conditions or establish a legal "standard of care" that facilities are required to follow.*

For example, a day room may be located within the sight line of a nurse station that “always has staff present.” However, if a patient who can’t sleep is in the day room watching television at 2 a.m. and the only staff member on duty is making rounds, the patient may be “completely alone” for a period of time in a space that may contain hazards.

This risk matrix is informed by Veterans Health Administration longitudinal studies that have identified frequent locations of acts of self-harm by inpatients, Joint Commission data, and Richard Prouty’s seminal work on risk maps. Designers and clinicians, rather than seeking agreement on what is meant by the name of a room, may now seek to agree on the actual or anticipated degree of aloneness or privacy a patient will experience in a room or space (independent of its name), and it is that agreement that will drive design choices for the room or space.

For example, a patient bathroom in which the patient is anticipated to be alone and have privacy would be far along the privacy axis. If that assessment intersects far along the patient intent for self-harm axis, the space should be designed with the attributes of a Level IV space as described in this document. In sum, no matter the name of the room, a high level of privacy warrants a high level of concern if it is anticipated that patients who are actively suicidal (or patients with an unknown or unassessed intent for self-harm) are to be treated or housed in that space. While different products may be used for spaces with risk assessments located in the Level IV quadrant of the risk matrix than for spaces in the Level I quadrant, the higher risk locations do not necessarily need to look more “institutional.”

The authors believe the use of a tool such as the environmental safety risk assessment matrix will facilitate necessary conversations regarding patient safety and design between operators, clinicians, and designers. However, the tool is not intended to predict risk levels in a facility, which the authors believe to be dynamic and non-static. Rather, it is intended to encourage dialog and promote a common understanding of the patients designed space is intended for and the risks of that anticipated patient population.

Also note that use of the matrix should not be interpreted as a suggestion that patient privacy is not important or is a risk to be avoided. On the contrary, privacy is generally considered desirable in the behavioral health built environment, although it is associated with a risk that should be considered and mitigated through good design where possible.

## EXHIBIT #1 - ENVIRONMENTAL SAFETY RISK ASSESSMENT



### Please Note:

The Environmental Safety Risk Assessment (ESRA) matrix was informed by the results of the VA Study, the colors for each ESRA Level are **NOT** intended for application on the ESRA floor plan indicating zones of safety risk.

We suggest the use of colors with significant hue contrast or use of poche line graphics that clearly delineate the differences between each ESRA zone.

### Environmental Safety Risk Assessment Level of Concern - Definitions:

- **Level I:** Areas where patients are not allowed.
- **Level II:** Areas behind self-closing and self-locking doors where patients are highly supervised and not left alone such as counseling rooms, activity rooms, interview rooms, group rooms as well as corridors that do not contain objects that patients can use for climbing and where staff are regularly present.
- **Level III:** Areas that are not behind self-closing and self-locking doors where patients may spend time with minimal supervision such as lounges, day rooms and corridors where staff are not regularly present. Open nurse stations should be considered under this Level
- **Level IV:** Areas where patients spend a great deal of time alone with minimal or no supervision, such as patient rooms (semi-private and private) and patient toilets.
- **Level V:** Areas where staff interact with newly admitted patients who present potential unknown risks or where patients may be in highly agitated condition. Due to these conditions, these areas fall outside the parameters of the risk map and require special considerations for patient (and staff) safety. Such areas include seclusion rooms and admission rooms.

This document is intended to represent leading current practices, in the opinion of the authors. It does not represent minimum acceptable conditions or establish a legal “standard of care” that facilities are required to follow.

## Construction and Materials Considerations

Each level of concern in the patient Environmental Safety Risk Assessment matrix requires increased attention to the built environment to reduce the potential for patients harming themselves or others. There truly is no “**one-size-fits-all**” solution to the design of these environments. Many factors must be considered and the patient populations, staffing patterns, organizational culture and challenges of the existing built environment are unique for each unit of each facility. The author suggest the following baseline set of considerations from which the staff of an organization can begin their considerations of what is the best solution for their facilities. The following suggestions may be adjusted to be either more or less restrictive as desired for individual applications.

### A. Baseline Considerations for Patient Accessible Areas

For the purposes of this document, the Author has designated the needs of **Level III** spaces to be defined as a “*Baseline Methodology*” for the conditions in all areas where behavioral and mental health patients will have access, both supervised and un-supervised.

As stated above, we consider these to be the “*baseline*” for a starting point or basis for comparison informed by leading practice conditions. TJC, FGI and other codes and regulatory bodies may be accepting of less stringent environment of care conditions, as the behavioral and mental health industry finds acceptable for organizations providing these services.

Part of the rational for this “*baseline methodology*” stems from many years of experience with these types of behavioral and mental health units. It is one thing to say that a particular room will always be locked when staff are NOT present, or that a particular type of chair designated for a specific room will always remain in that room and not find its way into a patient accessible area; however in reality, our concern is that this approach may be putting undue and unreasonable burden on the staff to constantly be responsible for these circumstances. The staff members are encumbered with many tasks, adding these things seems to be setting them up to overlook something that could ultimately have disastrous consequences.

The exceptions discussed under **Level II**, may be considered only after the provider organization has determined the space complies with the restricted patient access and staff supervision requirement. We strongly suggest that any behavioral and mental health provider organization adopt these Level II exceptions only after careful review with respect to their Environmental Safety Risk Assessment.

For areas that present unique special needs, items that we feel warrant more attention than discussed under the *Baseline Level III* are addressed in Sections for **Level IV and V**.



## 1. Openings

### a. Doors:

- i. Barricade Risks – The direction of swing is very important. Doors that swing into any room which patients may enter can be susceptible to being barricaded by patients. This can be either intentional or accidental (if a patient should lose consciousness and fall against the door). In either case, it can be very difficult for staff to enter the room when needed. If intentional, it can be to attempt self-harm or to inflict harm on a staff member or another patient. This risk can be mitigated in several ways listed below:

- Out-swinging doors
- Double-acting doors
- Door in a door (wicket door)
- Unequal pair of double egress doors
- Additional door in room with out-swing

- **Out-swinging Doors** – Doors that are hinged to swing out of the room are more difficult to barricade but may create issues with the Life Safety Code and other building codes by restricting the width of exit passageways. This may be addressed by recessing the door back from the face of a corridor wall which may create an alcove that is difficult to observe. **The FGI Guidelines warn that alcoves are to be avoided (FGI 2.5-1.5.1.1).**
- **Double-Acting Doors** – doors that are hinged to normally swing into a space, but staff may release to swing out of the space is one option to the barricading risk. The hardware needed for this solution is discussed below in the *Door Hardware* section.
- **Wicket Doors** – These are single in-swinging doors that have a portion of the door that is locked in the closed position and is hinged to swing out of the room. This can allow access to the room if barricading occurs.
- **Unequal Pair of Double Egress Doors** – If there is sufficient length of corridor wall present inside the room, a pair of doors can be provided. The active leaf is normal width and for normal use and is hinged to swing into the room. The inactive leaf is narrower and hinged to swing



**Out Swing Alcove**

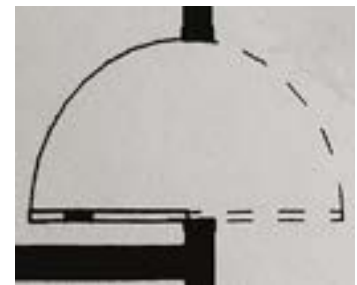

**In Swing - Dbl Act'g**

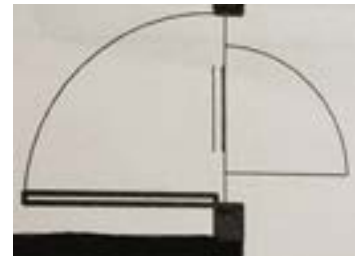

**In Swing - Wicket**

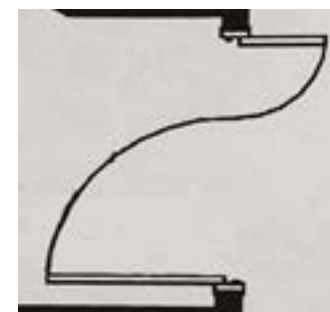

**Unequal Pair**



out of the room when unlocked by staff for emergency access. These can be done with or without a vertical frame member (mullion) between the two doors. Providing the mullion allows less complicated hardware and quieter operation. Not providing the vertical frame member results in additional opening width that is sometimes desirable, especially for movement of medical beds.

- **An Additional Out-swinging Door** can be provided that can be used by staff to leave the room or for other staff to enter the room. This can be an effective safety measure. The additional door may be into an adjacent room such as an office if the door is not needed for code compliance reasons. All “additional doors” provided for this purpose will need to be barricade resistant and meet all applicable codes and regulations.
- ii. **Door Materials** – Doors in behavioral health facilities are subject to heavy use and possibly extensive abuse. They make up a significant percentage of the exposed wall surface in corridors and thus have a strong visual impact on these spaces.
- Painted steel doors are durable, easily touched up or refinished, but more institutional in appearance. Doors with wood veneer faces and stain and varnish finish are more “residential” in character but are easily damaged and difficult to repair. Plastic laminate is easily chipped and may yield sharp objects that may be used as weapons and is never advised in these facilities. If existing doors have plastic laminate for exposed surfaces it may be desirable to provide stainless steel kick plates, door edges, and other add-on devices, although these can add to an institutional look. (NOTE: The installation of kick plates may invalidate the fire rating of doors in some jurisdictions.) Kick plates and other protective devices are also available in durable synthetic materials that come in a variety of colors, which soften the stainless-steel look but can still result in a patchwork appearance.
  - Durable Synthetic Facing - A possible solution to these issues is doors faced with a durable synthetic that has a wood grain appearance. Some of these doors have removable end caps,<sup>25a</sup> which can be replaced if they become damaged at much less expense than replacing the entire door. Doors with synthetic faces without the replaceable end caps<sup>25b</sup> are available for a lower initial cost.



Although the first cost for these synthetic-faced doors is higher than for doors of other materials, they do not require the added expense of finishing the doors and purchasing and installing kick plates, etc. Thus, the life cycle cost can potentially be less than for other doors, and the appearance over time may be a significant improvement.

**b. Door Hardware** – Hardware on doors that connect to a higher Level of Risk shall have hardware suitable for the higher level of risk.

**i. Double-Acting Continuous Hinges<sup>113</sup>** are preferred and can be used on patient room-to-corridor doors to counteract barricading without the hazard presented by pivot hinges. These continuous hinges can be paired with full-height emergency stops<sup>115</sup> that lock in place and can be easily unlocked to allow the door to swing into the corridor.



**ii. Gearing-Type Single -Acting Continuous Hinges<sup>111</sup>** are a solution for retrofit frame conditions at doors patients will pass through and normally locked doors that have hinges exposed in patient accessible areas because they minimize possible attachment points. These hinges are available from various manufacturers with a “hospital tip” (factory installed closed-sloped top) and continuous gears that resist ligature attachment.<sup>111</sup> Field cutting the top of hinges to create this slope is strongly discouraged because that often exposes voids that may be used as ligature attachment points.



Gearing continuous hinges do provide significant pinch points between the two leaves of the hinge when the door is closed. If this is not an acceptable risk to an organization, double acting continuous hinges that do not have this pinch point<sup>113</sup> can be provided.

**iii. Wicket Doors<sup>44</sup>** use single acting continuous hinges with hospital tips for the main door and the center portion is mounted on a continuous hinge with hospital tip (or concealed) hinge and secured with a deadbolt lock that has no visible hardware on the room side of the door. Care should be taken with the detail of the edge of the smaller panel so that a crack is not provided that can be seen through and is smoke tight if required.



iv. **Unequal Pair of Double Egress Doors**<sup>25b</sup> - both doors may be mounted on single acting continuous geared hinges with hospital tips. The lock-set can be the same as any other single-acting door. If the mullion is not provided, a deadlock with concealed bolts that engage the head of the door frame (and possibly the floor) is needed for the smaller inactive leaf. This deadlock is similar to item #143b except that it is preferred to not have any visible hardware on the room side of the door. If the mullion is provided, a deadbolt that does not have any exposed hardware on the inside can be used to secure the inactive leaf into the mullion



v. **Closers** – See Level II

vi. **Lock-sets** – Use of some type of ligature-resistant lock-set is recommended for all door handles in patient-accessible areas. A lock-set handle can be used for ligature attachment in three ways: pulling down, pulling up and over the top of the door, and tying something around the latch edge of the door using both the inside and outside handles (transverse). The latch-bolt itself has even been used successfully as an attachment point and some companies offer a tapered bolt to help with this. The downside to the tapered bolt is that it makes it easier to open a locked door by using a small piece of cardboard or other item. Also, the opening behind the strike plate can be a ligature attachment point; for this reason, a box should always be provided behind the strike plate. In our opinion, the perfect solution for this dilemma does not exist at this time. Several of the better options are discussed below.

- Lock-sets with a Lever Handle<sup>130</sup> – These effectively reduce the level of risk of up and down pressure but are susceptible to transverse attachment. The lever should move freely in both directions when locked to reduce ligature attachment risks. This type of handle is more typical (less institutional) in appearance and operation than other choices. Both of these qualities are very desirable in items that patients will touch and use on a regular basis. However, lever handles may be susceptible to transverse attachment as mentioned above.
- Crescent Handle Lockset<sup>136</sup> – This type of lock-set has a lever handle and thumb turn that are ligature-



**#130a**



**#136**

resistant and may meet ADA requirements. It is available with a handle that can be mounted in either horizontal or vertical position and allows the user's hand to easily slip off the free end.

- Push/Pull Hardware – This type of door handle is available with a flush push pad on one side and a ligature-resistant pull handle on the other.<sup>137b</sup>
- Modified Lever Handles<sup>131</sup> – These provide minimal ligature attachment risk but have an unusual appearance and operating motion. They are available in various designs.
  - Elopement Buffers** (generally called sally ports) – The 2018 Edition of the **FGI Guidelines** calls for the “*primary access point to the locked unit to be through a sally port*” (Section 2.5-2.2.1.2). The Appendix for this section states that a sally port has two doors (or two sets of cross-corridor doors) that are electrically interlocked<sup>144</sup> and “the sally port should be long enough and the door wide enough to accommodate passage of a bed or laundry cart.”
  - Access Control of Elopement Buffers** (sally ports) and other entry/exit points from a locked unit, including stairways.

The Environmental Safety Risk Assessment should state whether normally locked unit exit doors are going to automatically unlock when the fire alarm is activated (fail safe operation) or remain locked when the fire alarm is activated (fail secure operation). This determination should be reviewed with the local code authority for compliance with local regulations.

- Provide intercom (or telephone) for communication to staff stations from outside the unit if needed.
- Electronically controlled access systems are preferred for sally ports. These may be operated by a switch at the nurse station if the door is clearly visible from the location of the release button. (Care should be taken to assure that patients are not in the area when the door is released.) Card readers or keypads adjacent to the door are also commonly used. These



#137b



#131a



#131c

are readily available from hardware suppliers and are often extensions of systems already in place at the facility.

- Metal Detectors<sup>660</sup> – Some organizations have expressed the desire to use metal detectors to assist with screening patients and/or visitors entering their behavioral health facilities. Some choose to use hand-held detectors and others use standard walk-through detectors. These are addressed under Section #10 Electronic Safety.



#660

**iii. Cross-Corridor Doors** – These doors are provided for several reasons, and each has its own unique function and requirements. Some are part of code required fire rated partitions and normally held open and others are to restrict patient or public access and normally locked and may automatically unlock when the fire alarm is activated (fail safe operation) or remain locked when the fire alarm is activated (fail secure operation).

- When there is concern that electromagnetic locks may not be sufficient to hold these doors when impacted by patients, concealed deadbolts with the electric release in the lever handle<sup>109</sup> (or card reader) or electric strikes (for single doors) may be provided. Electronically controlled access systems are preferred.
- Door closers may be required or desired for these doors depending on their purpose and function. Doors that will be held in the open position will probably have an exposed arm that should be acknowledged in the Environmental Safety Risk Assessment as a known risk that the staff needs to be aware of.
- Magnetic hold-open<sup>101</sup> devices where required or desired for doors that are to be normally open and must close when the fire alarm is activated and are suggested to be as discussed below.
- Hinges for these doors are preferred to be continuous geared hinges with hospital tips. Pivot hinges are discouraged because the top pin is presents a serious ligature attachment risk.



#101



#### iv. Door Hold Open Devices

- Doors for which applicable codes and regulations require a closer but that need to be open to allow staff observation of patients are preferred to be provided with a closer that has a built-in release<sup>101</sup> that allows the door to close automatically when the fire alarm is activated. The more standard magnetic hold open devices that are separate items provide ligature attachment risks and are less desirable.

- v. **Door Smoke Seals** – These may be required in some situations and are often applied with adhesive strips that can allow patients to remove them to use as ligatures. Smoke seals that break into 8"- long pieces<sup>10</sup> are preferred for use on all doors that patients will pass through. These are available from several manufacturers.

- vi. **Door Hardware** for patient use toilet and shower room doors that open into patient accessible areas other than patient bedrooms are suggested to have the following:

- Full-size, tight-fitting doors
- Out-swinging geared continuous hinges with hospital tips or double acting hinges with emergency release stops
- Ligature resistant handles and storeroom function locks
- Closers that are either concealed or not mounted on the toilet or shower room side of the door.
- Over door alarms

- vii. **Over Door Alarms** - The top of all tight-fitting doors provides a pinch point that allows a patient to tie a knot (in a sheet, the leg of a pair of jeans, or other object), place it over the top of the door, and close the door to create a hanging device. One way to reduce this risk is with a pressure-sensitive or photoelectric device placed near the top of the door that will sound an alarm<sup>150</sup> when activated. The door bottom can also present a risk if the "gator roll" technique is attempted. One manufacturer can provide a product that will detect this also.

- c. **Windows** - When glazing that is exposed in patient-accessible areas is broken it needs to stay in the frame and not yield sharp shards that patients could use as weapons.

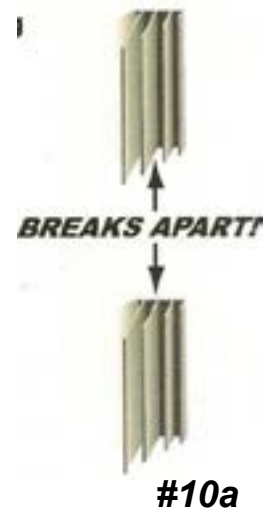

Terminology can be confusing in that laminated glass like that used in vehicle windows is often referred to as “safety glass” but, when broken, can yield large sharp pieces. All glazing materials that are exposed in all patient accessible areas should be considered, including the exterior surface of windows accessible from exterior courtyards to be used by patients.

The 2018 edition of the **FGI Guidelines** contains the following reference to window testing:

*2.5-7.2.2.5 Windows...*

*(1) Windows located in patient care areas or areas used by patients, including the exterior pane of windows accessible by patients for outdoor courtyards, shall be designed to limit the opportunities for patients to seriously harm themselves by breaking the windows and using pieces of the broken glazing material to inflict harm to themselves or others.*

*(a) All glazing (both interior and exterior), borrowed lights, and glass mirrors shall be fabricated with polycarbonate or laminate on the inside of the glazing or with any glazing that meets or exceeds the requirements for Class 1.4 per ASTM F1233: Standard Test Method for Security Glazing Material and Systems.*

*(b) Use of tempered glass for borrowed lights shall be permitted.*

*(2) To prevent opportunities for suicide, self-harm, and escape, the entire window system and the anchorage for windows and window assemblies, including frames and glazing, shall be:*

*(a) Designed to resist impact loads of 2,000 foot-pounds applied from the inside*

*(b) Tested in accordance with AAMA 501.8-13: Standard Test Method for Determination of Resistance to Human Impact of Window Systems Intended for Use in Psychiatric Applications. Where operable windows are used, hinges and locking devices shall also be tested.*

Advances in different types of safety glass (see “Glazing” below in this section) make it worthwhile to consult an expert for advice for a specific project.

- i. Exterior Windows** – The height above the ground, patient population, and many other factors should be taken into account in choosing these materials. Comply with the **FGI Guidelines** and all applicable codes and regulations for glazing, frame installation and operable sash.

In locations where the building’s prime window does not meet the requirements of the **FGI Guidelines**, an additional layer is sometimes provided inside of the prime window to provide the required protections.

- ii. **Interior Windows** - These do not have the same concerns of falling from heights as exterior windows, but breakage concerns are similar. Careful attention should be paid to fire-rated partitions and all applicable building and fire code regulations as well as the *FGI Guidelines'* requirements listed above.

Some facilities prefer to use painted hollow metal window frames for these windows because they have rounded corners and aluminum frames often have very sharp corners.

- d. **Operable Windows** – Windows in all patient-accessible areas should comply with all applicable codes and regulations for operable sash. Where operable windows are provided, they should be equipped with sash control devices that limit the opening to 4 inches per the NFPA 4” ball test and that, where required, can be released to full opening using a key for evacuation purposes. Window systems are also available that allow fresh air<sup>61</sup> through a vent at the bottom or by sliding the window open a few inches.

e. **Glazing - (Interior and Exterior) –**

- i. **Standards** – All glazing in patient-accessible areas should be security glazing as discussed in the *FGI Guidelines'* subparagraph “c” above.
- ii. **Impact-Resistant Glass Products** – Several glass manufacturers<sup>200</sup> offer products that may be appropriate for use in behavioral health facilities. The products chosen will vary depending on the size of the opening, type of frame, patient population being served, and location of the glazing in the unit (as determined by the patient Environmental Safety Risk Assessment) including the distance the opening is above grade. We suggest contacting manufacturers directly to determine which products may be appropriate for a specific project.
- Fire-Rated Glass<sup>205</sup> – Clear fire-rated glass products are now available in a variety of types and ratings and some are rated for impact resistance.
  - Glass-Clad Polycarbonate Glazing<sup>200</sup> – Two layers of heat-strengthened glass are bonded to a polycarbonate core. This combination keeps the broken material in the frame and reduces patient access to shards of glass that could be used as



#61b



#205a



#200a



weapons and is usually available in 7/16" and 9/16" thicknesses. This type of product has been known to be available for lower cost than polycarbonate glazing for some projects.

- Heat-Strengthened Glass – Although more difficult to break than regular float glass, heat-strengthened glass has about half the strength of tempered glass. Heat-strengthened glass may be a good choice if it is laminated and high-impact resistance is not required for the location.
- Polycarbonate<sup>201</sup> (Lexan) – Polycarbonate panels are highly impact-resistant and available in a variety of thicknesses from several manufacturers. These products will deflect upon significant impact near the center of large panels that can result in large pieces coming out of their frames. Care should be taken to assure that the depth of the stop securing the panel will be able to hold it when subjected to this and other impacts. This material is also highly susceptible to scratching and is a frequent target of patients who write profanity and draw pictures. Mar-resistant coatings are available, but they do not eliminate this concern. Recent projects have indicated this may be the more expensive than glass-clad polycarbonate products.
- Security Film – If replacing existing glass is cost-prohibitive, applying a window film security laminate<sup>190</sup> to existing glass may be an alternative. Although these films are susceptible to scratching and defacement by patients, they may be removed and replaced at less cost than replacing glass or polycarbonate panels. The manufacturer's installation instructions should always be carefully followed including any impact-protection adhesives and a perimeter attachment system needed to hold the panel in the frame, if broken. In our opinion, claims that these window films will prevent glass from breaking should not be relied upon.
- Tempered Glass – This may be acceptable for use in some patient-accessible areas such as small windows in doors, portions of glass walls separating

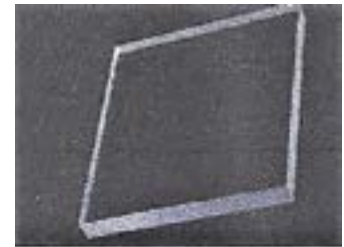

**#201a**

activity rooms from corridors, and patient toilet room mirrors. Tempered glass is more impact-resistant than float glass or laminated glass but will break into many small pieces and fall out of the frame, which may allow a patient to elope. As well, each piece may have sharp edges. Patients have been known to break tempered glass mirrors and rub the inside of their wrists on the broken surface to cut themselves or swallow the small pieces of glass. This hazard may be reduced by covering the tempered glass with a security film as described above.



#200

- Laminated/Heat Strengthened Glass<sup>200</sup> - Two layers of heat-strengthened glass bonded to a Sentry Glass Plus (SGP) interlayer, which helps the glass stay in the frame when broken.
- Wire Glass – Standard wire glass will break and yield sharp shards of glass and is generally not permitted by many current codes and regulations. There are new wire glass<sup>205b</sup> products that are rated for both security and fire by their manufacturers that may be considered. Verification with local AHJ is always recommended before purchasing new products.



#205b

## f. Window Coverings –

- Mini-Blinds** – Mini-blinds mounted behind safety glass<sup>200</sup> are preferred because the blinds are not accessible to patients. Care should be taken to assure that any exposed devices for controlling the tilt of the blinds do not create a potential ligature attachment point. Some commercially available window assemblies have all these features.<sup>430</sup> Exposed mini-blinds are discouraged because they provide access to long cords, wands and slats.
- Roller Shades**<sup>440</sup> – Roller shades specifically manufactured for use in psychiatric hospitals are another option.

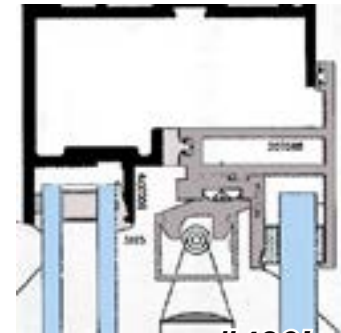

#430b

These have enclosed security roller boxes, security fasteners, cordless operation, and locking devices that resist tampering by patients may be acceptable for some patient populations. If access to these blinds by patients is deemed not acceptable by the Environmental Safety



#440a

Risk Assessment, electrically operated standard roller blinds may be installed behind security glazing.

iii. **Electrically Obscured Glazing**<sup>221</sup> is becoming more reasonably priced and is an option for controlling privacy as long as the glazing material meets the requirements of the **FGI Guidelines** for glazing in patient areas.

iv. **Curtains and Curtain Tracks** – Curtains and associated tracks of any type (including those designated as “breakaway” and represented by their manufacturers as “safe for psychiatric hospitals”) are NOT recommended for use in any patient-accessible areas, especially patient rooms and patient showers.



#221a

## 2. Finishes

a. **Gypsum Board** – Abrasion-resistant and impact-resistant gypsum board<sup>230, 231</sup> hung on 20-gauge or heavier metal studs spaced no more than 16 inches on center is typically considered minimum construction for these areas. Sound-deadening gypsum board<sup>232</sup> is available to help reduce noise levels from traditional hard surfaces. Consult manufacturers regarding the characteristics of the material determined most appropriate for a particular installation. These products are available from several manufacturers.

A painted finish is preferred because it is easy to repair and the cost of renewing or changing colors to keep up with current trends is relatively low. Also, painted finishes help create a residential or home-like ambiance while still meeting institutional requirements.

b. **Ceilings** – Ceiling heights lower than nine-foot-high are discouraged because it is easy for patients to reach them and tamper with the ceilings and ceiling-mounted devices. Ceiling heights of nine feet and above are not immune from tampering and must be evaluated in the Environmental Safety Risk Assessment for each area of each unit.

i. **Tamper-Resistant Ceilings** are preferred for all areas of a behavioral health facility. If sound attenuation for gypsum board ceilings is desired, sound absorbing gypsum board<sup>232</sup> may be used or 1'x1' acoustic tile can be adhered to the gypsum board.

ii. **Access** - Where accessibility to mechanical, electrical, and communication equipment is needed, The Joint

Commission's November 2017 Edition of Perspectives (modified by subsequent FAQ's also published in later editions of Perspectives) currently allows unsecured lay-in ceiling to be used under certain circumstances. As of this writing, the authors are not aware of any manufacturer who produces hold-down-clips that are specifically recommended for use to limit patient access above the ceiling. Systems relying on hold-down clips always result in the last tile being placed not being secured unless some form of locked access panel is provided to allow installation of the clip on the last tile.

**iii. Existing Ceiling Grid System** - There are several tamper-resistant solutions that can reuse the existing ceiling grid system and may be less expensive than typical gypsum board ceiling installation that may be considered:

- Remove existing ceiling tile and install specialty 2'x2' metal ceiling panels<sup>239</sup> with tamper-resistant screws in the recessed joints to resist removal. This system will allow access at any point and is available in sound absorbing models.
- Remove existing ceiling tile and install special clips<sup>234</sup> that are made to fit over existing grid members that are at least intermediate grade steel system (not aluminum). Then attach 5/8" thick sound absorbing gypsum board ceiling (mud and tape joints – paint) to these clips. Lockable access panels will be required at all necessary locations. It may be necessary to support light fixtures, etc. independently of the existing grid to avoid overloading the carrying capacity of the existing grid.

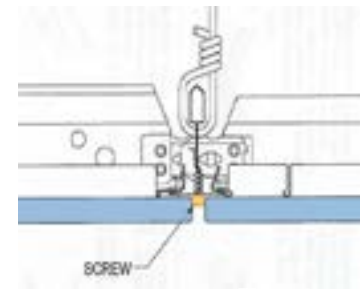

#239a



#234a

**b. Wall Base** – Use of thin, flexible rubber or vinyl baseboards that are applied only with adhesive and are intended to cover the joint between the wall and floor is strongly discouraged. These become prime targets for patient tampering and can be used to conceal contraband.

There are several alternative choices for base material and installation that may offer less risk:

- i. Seamless epoxy flooring<sup>250</sup>** that has an integral covered base is an option as long as there is no metal or plastic edge strip on the top of the base.



#250c

ii. **A premolded base**<sup>240</sup> that extends onto the floor plane, finishes flush with the top of the floor tile, and is heat-welded to the flooring may be acceptable in some locations. However, use of this product does not address the issue of hiding contraband unless the top edge is sealed with a pick-resistant sealant.<sup>20</sup>



#240

iii. **Wall and Floor** A thick rubber base that resembles wood base profiles<sup>241</sup> is available and provides a more “residential” appearance. All joints to the wall and all vertical joints should be sealed with a pick-resistant sealant.<sup>20</sup>



#241a

iv. **Wood Base** - in some cases, a wood base with a minimum ¾” thickness that is adhered to the wall, secured with countersunk tamper-resistant fasteners, and sealed with pick-resistant sealant<sup>20</sup> has been used successfully. If desired, this can be given a semi-transparent stain finish to provide more of a residential look.

b. **Flooring** – Carpet<sup>255</sup> or sheet vinyl<sup>245</sup> meeting class A rating should be used. Avoid patterns and color combinations that may appear to “animate”, abrupt contrasting color changes that could appear as objects that need to be stepped over or other visual mis-perceptions by patients. Anti-microbial sheet carpet (formerly called “broadloom”) with solution-dyed yarn and moisture-resistant backing<sup>255</sup> is effective in reducing ambient noise and generally works well in these facilities. This is available from most major carpet companies. Sheet vinyl<sup>245</sup> or other hard surface material is preferred where wet or potentially messy activities will be conducted.

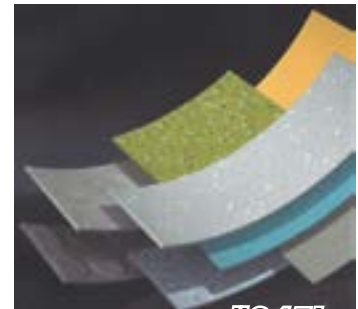

#245b

c. **Abrasion Resistant Coatings**<sup>280</sup> – Any areas where excessive wear is anticipated, such as corridors and seclusion rooms without wall padding may be coated with paint materials that have more resistance to abrasion and possible abuse.

### 3. Specialties

#### a. Signage – Room Signs<sup>300</sup>

i. **Flexible Room Signs** are available that are applied with adhesive and will not provide a weapon to patients if removed. These can include braille lettering and meet ADA requirements.



#300b



- ii. **Rigid room signs**<sup>300d</sup> that are installed with multiple tamper-resistant screws are more difficult to remove and also can include braille lettering to meet ADA requirements.



#300d

- b. **Corridor Handrails** – may not be required in behavioral health units but may be indicated as needed by the Environmental Safety Risk Assessment because of needs of the patient population being served having equilibrium issues due to medication side effects or other reasons. If these are provided, there is a choice between leaving the anchors for the rail exposed (which creates ligature attachment point opportunities) and providing a solid filler between the rail and the wall (which helps reduce ligature attachment points and creates a place for trash to collect and can be an infection control cleaning problem). The “correct” answer for any given section of railing will depend on the facility’s Environmental Safety Risk Assessment and the amount of observation of the specific location.



#330a

- c. **Wall Protection** – Large sheets of durable wall protection material are available in solid color finish or with a wide variety of printed artwork.<sup>320</sup> However, the standard vinyl trim pieces that come with this material are not recommended for use in behavioral health applications. Rather, the edges of the material are suggested to be tightly fitted together and sealed with pick-resistant caulk.<sup>20</sup>



#320

- d. **Toilet Accessories** – See Level IVb

#### e. **Mirrors and Domes:**

- i. **Mirrors** - Glass-laminated polycarbonate mirrors in ligature resistant wood frames<sup>360</sup> offer an option with a residential appearance and are scratch resistant. (See also Level IVb-3f for toilet room mirrors)
- ii. **Observation Dome Mirrors** – Convex mirrors installed in corridors, seclusion rooms, and other patient-accessible locations to assist with observation of patients are preferred to be made of a polycarbonate that is a minimum of 1/4” thick, filled with high-density foam, and have a heavy metal frame that fits tightly to the wall and ceiling.<sup>420</sup> Convex mirrors made of polished steel are also available. The perimeter of the mirror is recommended to be sealed with pick-resistant caulking.<sup>20</sup>



#360a



#420a

**f. Pick-Resistant Caulk** – Pick-resistant caulking<sup>20</sup> is strongly suggested for all joints between objects and surfaces that do not fit tightly and may provide opportunities for patients to hide contraband, attach ligatures or grip items to remove them. It is preferred that this material not set up hard (like epoxy) but remain pliable and be able to move with its substrate over time. Verify compatibility with all adjacent materials before application.



#20b

**g. Paper Trash Receptacle Liners** - Coated paper liners<sup>1</sup> are strongly suggested for all trash receptacles to which patients have access including large receptacles in dining and activity spaces. Paper liners with rope handles may present ligature risks. Plastic liners should be prohibited because of the risk of suffocation.



#1

**h. Kitchen Equipment Considerations** - (Levels II and III only)

## 4. Furnishings

**a. Built-in Cabinets** - (securely anchored in place)

**i. Cabinet Doors** -

- All cabinets that contain items that patients are not to have access at all times they are present in the space are strongly suggested to have lockable doors.
- Cabinets that contain items that patients are allowed to access at all times they are in the space are strongly suggested to not have doors and to have shelves that are securely fixed in position to resist both upward and downward pressure. Adjustable shelves are discouraged because they are easily removable and may be used as weapons.

**ii. Cabinet Pulls** – These are suggested to be recessed, with no protruding openings, or of a closed ligature-resistant type.<sup>460</sup>

**iii. Cabinet Locks** – These are very important in all patient-accessible areas. Cabinets used to store items that patients could use to harm themselves or others should be kept locked at all times when patients are present. This can lead to staff constantly looking for

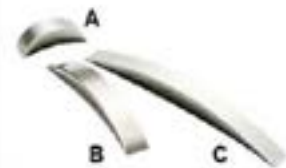

#460a

the right key on a large key chain. One solution is to provide locks that can be unlocked with a key that staff already carry, such as the key used to activate the fire alarm. Another solution is to use existing key access cards or a pushbutton keypad.<sup>465</sup> These are becoming more affordable and should be particularly helpful in examination/treatment rooms and any locked cabinets in patient rooms.



#465a

**b. Decorative Crafts - Pictures and Artwork –** All pictures and artwork in patient-accessible areas must be given special consideration:

**i. Murals –** These can brighten and add interest to corridors and day rooms and have been used very effectively in some facilities. It is usually a good idea to cover them with at least two coats of a clear sealer for protection, but patients typically enjoy these and defacing them is not usually a problem. Murals are also available on wall vinyl and wall protection materials.



**ii. Wall Protection –** Large sheets of durable wall protection material are available with a wide variety of printed artwork.<sup>320</sup> However, the standard vinyl trim pieces that often come with this material is not recommended for use in behavioral health applications. Rather, the edges of the material could be tightly fitted together and sealed with pick-resistant caulk.<sup>20</sup>



**iii. Frames –** Specially designed frames<sup>476</sup> that do not provide a recess at the perimeter that might be used for ligature attachment and have polycarbonate<sup>201</sup> glazing are recommended. The frames that are screwed to the walls with a minimum of one tamper-resistant screw<sup>470</sup> per side are preferred to provide a tight fit to walls which may have uneven surfaces. The joint at the top is suggested be sealed with a pick-resistant sealant.<sup>20</sup> Some of these frames allow for easy replacement of the images and provide the opportunity for patients to customize the displays with personal photos, etc.



#320b

**iv. Printed Flexible Vinyl –** Another option is to print artwork on flexible vinyl<sup>301</sup> that can be attached to walls with low-tack adhesive or regular wall vinyl adhesive for more permanent installations. This method reduces the risk of patients obtaining harmful materials. The low-tack adhesive used on smaller images makes it easier



#476b



to change the art displayed on a seasonal or other basis and allows hospitals to offer patients a choice of artwork to display in their rooms, giving them some control over their environment.

**c. Seating** - Furniture used in behavioral health facilities is preferred to be easily cleaned, easily reupholstered, very sturdy, and as heavy as possible to minimize the likelihood of patients throwing chairs, tables, etc. Where indicated by the Environmental Safety Risk Assessment, furniture is suggested to be securely anchored in place or weighted to resist stacking or barricading of doors. Closed arms and legs are preferred to resist attachment of ligatures and breaking into items that could be used as weapons.<sup>482</sup> Upholstered lounge chairs with arms<sup>482</sup> that resemble typical residential furniture are generally preferred, but polyethylene rotationally molded<sup>483</sup> and sand-ballasted seating is now available with a less institutional look. The health care organization should select furniture appropriate for the patient population served and the location on the unit for which it is intended.



#482h



#482a



#483

Where movable seating is needed (e.g., dining and activity rooms), very lightweight polypropylene chairs<sup>480</sup> that resist breaking into sharp pieces are preferred. An alternative is a chair that can be partially filled with sand (or otherwise have weight added) to make it difficult to throw or use as a weapon.<sup>480</sup>

Comfort Rooms and other lounge areas may have specialty type seating, chaise lounges<sup>482i</sup> or bean bag<sup>481d</sup> that are manufactured without zippers, constructed of very durable materials and seams.



#480b

Rocking motion has long been believed to be soothing and several companies now offer specially designed seating that allow a rocking motion.<sup>483</sup> **Care should be taken to realize that it is not uncommon for unauthorized movement of furniture from a low-level risk area to a higher risk area of a unit to occur. This may result in unintended risks being created.**



#483b



#481



#482i

All upholstery and foam used in furniture should have flame-spread ratings that comply with the requirements of Section 10.3 of **NFPA 101: Life Safety Code®** and all other applicable codes and standards.

#### d. Furniture:

- i. **Tables for dining and activities** are available with enclosed legs<sup>485</sup> and provide less opportunities for ligature attachment. These are usually either center pedestal or “X” base style. Both can be weighted down with sand to reduce the chance that they can be picked up and thrown but can still be movable. A range of styles and shapes of tops are available for both types.
- ii. **End tables and coffee tables** are available in enclosed cubes or drums<sup>485c</sup> and other configurations that are also ligature resistant and can be weighted.
- iii. **Shelving units** for items to which patients will have free access are suggested to be sturdy, have open shelves that are fixed in place (not adjustable) and securely anchored in place. The tops of taller units are suggested to be sloped to resist storage and anchored to resist them being tipped over.



#485a



#485c

## 5. Fire Suppression

- a. **Fire Sprinkler Heads** - Institutional heads<sup>520</sup> that are ligature-resistant are preferred.
- b. **Fire Extinguisher Cabinets** - All fire alarm pull stations and all fire extinguisher cabinets<sup>521</sup> are suggested to be locked (with approval of all applicable code authorities). All staff on duty must carry keys for these at all times. These keys should be provided with a red plastic ring or other means of providing quick identification. In addition, fire extinguisher cabinets are preferred to have continuous hinges, recessed pulls (if any), and polycarbonate glazing if view windows are provided.



#520a



#521a

*This document is intended to represent leading current practices, in the opinion of the authors. It does not represent minimum acceptable conditions or establish a legal “standard of care” that facilities are required to follow.*

## 6. Plumbing Fixtures and Fittings

- a. **Toilet Fixtures** – Patient accessible toilets are always considered Level IV and V areas and are addressed in those sections.
- b. **Sinks** –
  - i. **Standard Stainless-Steel Sinks** may be permitted if that is consistent with the organization’s Environmental Safety Risk Assessment and are suggested to be designed into recesses with doors or roll-down shutters that can be locked when staff are not present.
  - ii. **Bathroom Sinks** are addressed in Level IV and V sections.
  - iii. **Hand-washing Sinks** for staff that are in patient accessible areas are suggested to be specially designed units. See subparagraph “h” below.
- c. **Showers** - Patient accessible showers are only permitted in Level IV and V areas and are addressed in those sections.
- d. **Faucets** – Patient use faucets are primarily inpatient bathrooms and are addressed in Levels IV and V. Faucets in activity and similar rooms are addressed in Levels II and III.
- e. **Flush Valves** - Patient accessible flush valves are permitted only in Level IV and V areas and are addressed in those sections.
- f. **Water Stations** – Ligature-Resistant Drinking Water Stations<sup>589</sup> – Drinking fountains are often required or desired in common spaces on units. Typical drinking fountains can be problematic for ligature and infection control reasons but requiring patients to ask staff every time they want a drink of water can rank high on patient dissatisfaction surveys.



#589b

To address this issue, consider use of water cup-filling stations in patient-accessible areas. Several options are available for cup-filling stations<sup>589</sup> that have either local or remote refrigeration units, in both wall-mounted and counter-top styles.

- g. **Medical Gases** – These are not normally required for behavioral health units. If there is medical necessity or the outlets are a preexisting condition in remodeling projects,



#590c

they should be covered with lockable panels<sup>590</sup> or panels attached with tamper-resistant screws. These should be removed only to address the medical needs of the current patient and replaced when that patient is discharged or moved. Special care must be taken in areas where other patients may be present to assure that access to the medical gases does not present a safety risk to them also. Some manufacturers offer lockable covers for outlets.

- h. Staff Hand-washing Stations** - Staff Hand-washing stations<sup>545</sup> for patient accessible areas are now available that provide less risk than standard fixtures. These are recessed and have integral soap dispensers and air dryers to eliminate the need for separate dispensers which may also provide risks. All hand-washing sinks that are accessible to patients need to be ligature-resistant.



#545



## 7. Heating, Ventilation & Air Conditioning (HVAC)

- a. Diffusers, Registers and Grilles** - Grilles with small perforations<sup>602</sup> or with “S” shaped vanes<sup>600</sup> that comply with the National Institute of Corrections standards and are secured in place with tamper-resistant fasteners are generally acceptable in patient accessible areas if allowed by the Environmental Safety Risk Assessment.
- b. Where existing fan/coil units** (as well as fin-tube heaters or old-style radiators) are present in patient accessible spaces, they are strongly suggested to be protected with vandal-resistant covers.<sup>606</sup>
- c. Thermostats** – Existing pneumatic or electric thermostats may be acceptable for use in patient accessible areas if allowed by the Environmental Safety Risk Assessment. If they are found to be problematic, there are covers available to reduce the risk of patients tampering with them and gaining access to small parts which they could use to harm themselves or others. However, sometimes these covers draw more attention to the thermostats and encourage tampering. If these become an issue or are an identified risk in the Environmental Safety Risk Assessment, consideration could be given to relocating the thermostats to return air ducts or use of aspirating or thermistor units that are mounted behind a stainless-steel cover that is flush with the wall.<sup>607</sup>

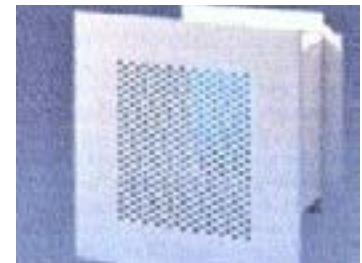

#602a

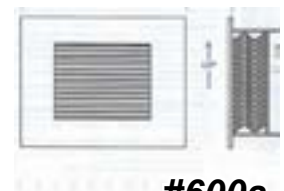

#600a

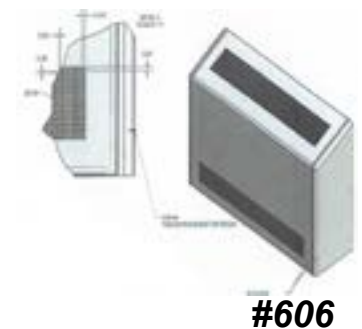

#606

## 8. Electrical

### a. Electrical Devices:

- i. **Receptacles** - In new construction or major remodeling, the **FGI Guidelines** require a dedicated circuit for all electrical outlets in each patient room and bath. This will allow power to the outlets in a specific room to be turned off if necessary for a patient's safety. Control of each circuit should be located where only staff have access. Where this is not practical in an existing facility, the outlet may be temporarily covered.
- ii. **FGI Guidelines** also state that all electrical outlets in patient rooms and patient toilet rooms be a hospital-grade, tamper-resistant type. Use of GFCI protection receptacles<sup>610</sup> is also preferred to reduce the risk of patients being able to harm themselves by tampering with the receptacles. Arc-Fault protection receptacles are required by the latest National Electrical Codes in kitchens and laundry rooms, and should be reviewed by the provider organizations Environmental Safety Risk Assessment for consideration in other patient areas.
- iii. **Cover Plates** - All electrical device cover plates (for switches, receptacles, blank cover plates, etc.) must be attached with tamper-resistant screws.<sup>470</sup> Cover plates made of polycarbonate<sup>612</sup> materials are preferred; polycarbonate cover plates must have screws in each corner to make them rigid enough to resist bending and protect patients from access to electrical wiring and contacts. Nylon cover plates and ones marketed as "unbreakable" are typically not sturdy enough to resist tampering by patients. Standard stainless-steel cover plates that fit tightly to the wall and are rigid may be acceptable for many patient populations if allowed by the Environmental Safety Risk Assessment. These may be secured with a single tamper-resistant screw in the center as long as it is securely tightened. The tightness of these screws and fit to the wall is suggested to be included in regular safety rounds documentation.



#610



#612c



620b

### b. Light Fixtures:

- i. **Tamper-Resistant** - All fixtures that can be reached by patients are suggested to be a tamper-resistant type<sup>620</sup> and have minimum ¼"-thick polycarbonate (clear or



prismatic) lenses<sup>634</sup> securely fixed in the frame with covers that are firmly secured with tamper-resistant screws<sup>470</sup> and fit tightly to the ceiling surface.

- ii. **LED** - Advances in LED technology have resulted in new options for light fixture designs that can help reduce the institutional character of these spaces. The authors strongly encourage the use of these options and discourage the use of 2'x2' and 2'x4' light fixtures in all patient accessible locations. Our preference is for using linear, round or oval vandal-resistant fixtures for general illumination and recessed security downlights with polycarbonate lenses or small individual reading lights.
- iii. **Color Temperature** - The availability of tunable lighting (ability to adjust the color temperature of the light source) is encouraged as is the use of circadian lighting systems.
- iv. **Glass Components** that could be accessed by patients are discouraged for use in any fixture. Use of table lamps or desk lamps are also strongly discouraged. Neither incandescent light bulbs nor fluorescent tubes should ever be accessible to patients.

- c. **Exit Signs - Lighted Exit Signs<sup>640</sup> or Photo-luminescent Signs<sup>642</sup>** – These are suggested to be vandal-resistant and installed tight to the ceiling with a full-length mounting bracket to avoid use as a hanging device. Mounting these signs on a wall so they are perpendicular to the wall is not recommended because it leaves the top exposed as a possible attachment point.



#620c



#624



#640a

## 9. Communications

- a. **Telephone Sets** - Telephones located in corridors or common spaces for patient use should have a stainless-steel case,<sup>645</sup> be securely mounted to the wall, and have a non-removable shielded cord of minimal length (as approved by the Environmental Safety Risk Assessment) with cable tether inside the shield. They may be equipped with or without touch pads for placing outbound calls. Some organizations have a switch installed in a staff area to deactivate patient use phones at times when patients are not allowed to make calls.

Some facilities are now providing cordless phones for patient use.



#645a

- b. Duress Alarms** – Patient to staff injuries are a significant concern in many facilities. One way to address this (other than designing the unit to eliminate locations where staff may become isolated with a patient and become trapped) is to provide some type of personal duress alarm system<sup>650</sup> that staff members can wear and activate when needed. It is preferred that these systems provide information on the location of the staff member when the alert is sent. Some of these can interface with other systems that may already be present in the facility and even use existing wi-fi systems for connectivity.



#650f

## 10. Electronic Safety

- a. Metal Detectors** - Some organizations have expressed the desire to use metal detectors to assist with screening patients and/or visitors to their behavioral health facilities. Some choose to use hand-held detectors and others use standard walk-through detectors. Organizations considering metal detection solutions may want to investigate ferrous metal detection systems<sup>660</sup> that sense the presence of ferrous metal in objects such as razor blades, syringes, lighters, cell phones, knives and guns. These systems will not detect drugs or other nonferrous metal contraband items.



#660

## 11. Exterior Improvements - Outdoor Areas

- a. Enclosed courtyards**, fenced areas adjacent to a treatment unit, or an open campus are considered to have great therapeutic benefit. Because levels of staff supervision for patients using outdoor areas may vary widely between facilities, or even between different groups using the same space at different times, the need for supervision should be carefully reviewed by management early in a design and construction project. The final design for outdoor areas must respond to the acuity and assessment of the most acute patients using the area and the planned staffing levels for each patient population.
- b. Fencing** - Climbable fences can permit, if not encourage, unauthorized access to windows and roofs or elopement over walls. Buildings, walls, or fences may be used to establish clear boundaries and impede elopement to a



#675d

degree appropriate to the patient population being served. Some behavioral health organizations are comfortable with a perimeter enclosure that is not particularly difficult to climb and simply make elopements a treatment issue if the patients return. Other organizations have a very high need to reduce elopements to the extent possible. Where this is the case, designers may tend to create enclosures that have a very prison-like appearance. If views to the distance are not required, one approach is to treat the outdoor areas as meditation gardens with solid masonry walls that have a smooth interior surface and are 12 to 14 feet high.



**i. Top Fence Protection** - One facility installed large diameter (22"-24") plastic pipe on top of the wall to make it difficult for patients to get a grip on the top surface. This pipe can be painted to match the color scheme of the building and provides a much less institutional appearance than concertina wire. If views to the distance are desired, "windows" glazed with polycarbonate<sup>201</sup> or security glass<sup>200</sup> may be provided in these walls. These view panels should not have sills or cross bars that could provide footholds for climbing.

**ii. Fence Material** - Another option is installation of a fine mesh chain-link fence fabric.<sup>675</sup> This fabric, which comes in a range of sizes down to as small as 3/8" openings, makes the fence more difficult to climb and has openings that are too small for most bolt cutters. When installing such material, fence posts and rails must be strong enough to support the fabric and the wind loading it will add. In at least one instance, a patient successfully climbed a mini-mesh fence, so it is suggested a section at the top be angled inward to further increase the difficulty of climbing at the cost of increasing institutional appearance.



#675a

**iii. Maximum security fencing**,<sup>675b</sup> which has a very prison-like appearance, may be selected for some facilities with involuntarily admitted patients. However, it is suggested that the use of less institutional-looking solutions be explored before deciding to use this type of material.



#675b

**iv. Enclosed Courtyard** - Where portions of the building walls will enclose exterior courtyards for patient use, these walls should not be easily climbable, especially if they are only one story high. Windowsills, rain gutters, and similar features may support efforts to climb walls



to gain access to the roof. The exterior surface of all windows patients can access from exterior courtyards must have security glazing,<sup>200</sup> polycarbonate glazing,<sup>201</sup> or security window film,<sup>190</sup> as described under Level II-D.

- c. Outdoor Furniture** - In all cases, careful consideration should be given to exterior furniture used by patients. All outdoor furniture<sup>510</sup> is suggested to be firmly anchored in place. This will resist the furniture from being moved to create barricades or stacked to allow climbing over fences, into windows, or onto buildings. Many types of commercially available furniture can be anchored or are made of concrete or other heavy materials.
- d. Plant Materials** - Shrubbery should be non-toxic and low-growing. Avoid planting shrubbery close together as it can create visual barriers that patients or unauthorized visitors may hide behind. Landscape mulch or decorative rocks that can be thrown to injure staff or other patients should not be used. Trees should be located away from buildings, walls and fences to reduce ease of access to roofs or getting over fences.
- e. Area Drains and Manhole Covers** - All manhole covers, access panels, and area drain grates should be anchored firmly in place to discourage easy removal and use as weapons and to make it difficult for patients to enter the underground piping.
- f. Public Areas** - All areas surrounding patient use buildings, areas where staff will walk or escort patients at night, and courtyards should be well-lighted. Exterior lights should not shine directly into patient room windows. Parking areas for staff and visitors should be well-lighted and reviewed regularly for design features that encourage personal and property security. While security is generally beyond the intended scope of this document, closed-circuit television monitoring and video surveillance recording of these semi-public areas, where there is no expectation of privacy, should be considered.

## END OF BASELINE SECTION

## B. Level I

### *Areas where patients are not allowed:*

***All items do NOT need to comply with Baseline conditions but are suggested to meet the following:***

1. Comply with all applicable codes and regulations.
2. All service areas should be locked at all times to reduce the possibility of patients entering these spaces.
3. Hardware on doors that connect to a higher Level of Risk (accessible to patients) shall have hardware suitable for the higher level of risk.

The **Level I** spaces and rooms can be considered areas where the behavioral and mental health patient ***NEVER*** crosses the threshold of the door to enter a restricted, staff only area.

Along the perimeter of **Level I**, staff only spaces, around the perimeter of this zone the patient may have access to one side of the door and the hardware for this door. As mentioned at item #3 above, the patient accessible side of the door suggest to comply with the Environmental Safety Risk Assessment higher level of concern for that patient accessible area. In addition, the doors located at the transition into **Level I** space suggest to include self-closing and self-locking hardware, and if a closer is applied to the door, the closer suggested to be mounted on the Level I staff only side of the door.

**Level I** staff only spaces may comply with “*building standard*” interior finishes, fixtures, furniture and equipment.

## END OF LEVEL I SECTION

## C. Level II

**Areas behind self-closing and self-locking doors where patients are highly supervised and NEVER left alone; examples of Level II spaces could be counseling rooms, activity rooms, interview rooms, group rooms, exam rooms, as well as corridors that do not contain objects that patients can use for climbing and where staff are regularly present:**



**West Springs Hospital - Art Room**

Architect of Record - Davis Partnership, Denver,CO: Photographer - Paul Brokering Photography



**West Springs Hospital - Corridor**

Architect of Record - Davis Partnership, Denver,CO: Photographer - Paul Brokering Photography

*This document is intended to represent leading current practices, in the opinion of the authors. It does not represent minimum acceptable conditions or establish a legal “standard of care” that facilities are required to follow.*

**All items same as Baseline with the following exceptions:**

Our recommendation is that the Baseline, Level III conditions represent the *Leading Practices* for behavioral and mental health facilities. However, it is our understanding The Joint Commission (TJC) recommendation at the time of this publication will accept the following revisions as stated below in **Level II** areas. It is strongly suggested that these revisions only be made after careful consideration and if these variations are consistent with the organization's Environmental Safety Risk Assessment. The Environmental Safety Risk Assessment should identify all standard items that typically are not allowed on inpatient behavioral health units that are present in rooms that are defined as Level II in this document.

An examination room is required by the FGI Guidelines. When the exam room is located on the unit, the equipment in these rooms present potential risk; therefore suggested to be designated as a Level II with self-closing and self-locking doors. The room is suggested to be large enough to allow several staff to physically manage the patient. If possible, a staff member should not be in the room alone with a patient.

## 1. Openings

- a. **Doors** - Barricading considerations discussed in Baseline section above are highly recommended for doors to all rooms that patients will enter.
- b. **Door Hardware:**
  - i. **Self-Closing Self-Locking** - All rooms designated to allow patients access with staff supervision only, such as counseling rooms, interview rooms, exam rooms and other rooms patients may enter only when staff are present, are required to have self-closing and self-locking doors.
  - ii. **Storeroom Function** - For Level II rooms to comply with the ESRA definition calling for self-locking hardware, are suggested to have "storeroom" function lock-sets with which the doors will always be locked from the outside when closed and latched. The inside lever will always be free.
  - iii. **Closers** are needed for Level II rooms which TJC requires to have self-closing and self-locking doors and that staff must ALWAYS be present when patients are in the room.

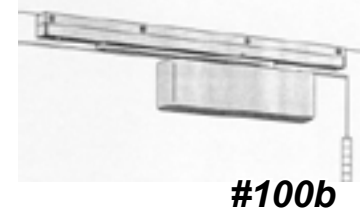
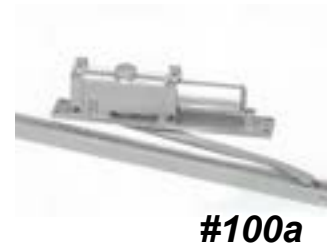

They may be required for other doors by building and life safety codes or because the staff want to assure that a particular doors are not accidentally left open for operational reasons. Where provided, concealed closers<sup>100a</sup> that have the closer and the track both completely contained in the head of the door and frame offer the least amount of ligature attachment opportunity (the arm is only exposed when the door is open). However, these require special preparation of the door and frame and are difficult and expensive to provide in existing conditions. Where concealed closers are not practical, it is suggested that surface mounted track closers<sup>100b</sup> be provided and located on the side of the door that either patients are not allowed (Level I spaces) or where the closers are most observable by staff.

## 2. Finishes

- a. **Ceilings** – Our understanding of current TJC recommendations is that accessible lay-in type ceilings are acceptable in Level II spaces if that is consistent with the organization’s Environmental Safety Risk Assessment.
- b. **Wall Base** – Standard surface applied thin vinyl or rubber base may be acceptable if that is consistent with the organization’s Environmental Safety Risk Assessment.

## 3. Specialties

- a. **Kitchen Equipment:** (Similar to Level III except may not need to be lockable if acceptable under the Environmental Safety Risk Assessment.)

## 4. Furnishings

The use of furniture that is lighter weight, easily movable and that has obvious opportunities for ligature attachment in Level II rooms may be acceptable to TJC and can be considered for use if it complies with the findings of the Environmental Safety Risk Assessment performed by the provider organization.

The behavioral and mental health provider organization should select furniture appropriate for the patient population served and the location on the unit for which it is intended. Care should be taken to realize that it is not uncommon for unauthorized movement of furniture from a low risk area to a higher risk area of a unit to occur. This may result in unintended risks being created.

- a. Seating** - Open arms and legs on un-weighted furniture that is not securely fixed in position may be acceptable if consistent with the Environmental Safety Risk Assessment. High-quality wood, steel or plastic chairs for use at tables may be more standard products. Upholstered lounge chairs<sup>482</sup> that resemble typical residential furniture are generally preferred.
- b. Tables** may be more typical style<sup>485</sup>, have individual legs at the corners and be easily movable to accommodate a range of uses and activities; consideration for weighted tables for Level II areas.
- c. Bookcases and Cabinets** - Same as Baseline except as may be allowed by Environmental Safety Risk Assessment for areas behind self-closing and self-locking doors as discussed above.



#482j



#485b

## 6. Plumbing Fixtures and Fittings

- a. Toilet Fixtures** - Level IV and V areas only
- b. Sinks** – Standard stainless-steel sinks may be permitted if that is consistent with the organization’s Environmental Safety Risk Assessment, but caution is recommended.
- c. Showers** - Level IV and V areas only
- d. Faucets** - Standard goose-neck faucets and standard valve handles may be permitted in activity and similar areas that are consistent with the organization’s Environmental Safety Risk Assessment, but caution is recommended.
- e. Flush Valves** - Level IV and V areas only
- f. Medical Gases** - Not typically present in Level II areas

## 7. HVAC

- a. Diffusers, Registers and Grilles** – Standard products may be acceptable if that is consistent with the organization’s Environmental Safety Risk Assessment. Products consistent with Level III suggestions are recommended.



- b. Thermostats** – Standard products may be acceptable if that is consistent with the organization’s Environmental Safety Risk Assessment. Products consistent with Level III suggestions are recommended.

## 8. Electrical

- a. Electrical Devices:** Standard products of this type may be acceptable if that is consistent with the organization’s Environmental Safety Risk Assessment and local code authorities.
- b. Light Fixtures –**
- i. **Standard products** may be acceptable if that is consistent with the organization’s Environmental Safety Risk Assessment. Products consistent with Level III suggestions are recommended.
  - ii. **Covers<sup>630</sup>** are available for existing (or new) downlights that are secure and make the appearance more residential in nature.
  - iii. **No glass components** should be exposed to patients in any fixture and use of table lamps and desk lamps is strongly discouraged.
- c. Exit Signs** - Standard products may be acceptable if that is consistent with the organization’s Environmental Safety Risk Assessment. Products consistent with Level III suggestions are recommended. The mounting bracket suggested to be full length of the fixture.
- d. Security Lighting** - Standard products may be acceptable if that is consistent with the organization’s Environmental Safety Risk Assessment. Products consistent with Level III suggestions are recommended.



## END OF LEVEL II SECTION

## D. Level III

**Areas that are NOT behind self-closing and self-locking doors where patients may spend time with minimal supervision such as open lounges, day-rooms and corridors where staff are not regularly present. Open nurse stations are suggested to be considered under this Level because there may be incidents where staff will not always be present in these spaces:**



**Mercy Health Saint Mary's - Day Room**

Architect of record: Progressive AE, Grand Rapids, MI - Photographer: JRP Studios



**West Springs Hospital - Day Room**

Architect of Record - Davis Partnership, Denver, CO: Photographer - Paul Brokering Photography



**Mainline Health Bryn Mawr Hospital - Day Room**

Architect of Record - CRTKL, Dallas, Texas - Photographer Kim McMurray (Field Visit)

*This document is intended to represent leading current practices, in the opinion of the authors. It does not represent minimum acceptable conditions or establish a legal "standard of care" that facilities are required to follow.*

**All items shall be the same as Baseline with the following exceptions:**

### 3. Specialties

#### a. Kitchen Equipment: (Typically Levels II and III only) -

All cooking appliances (ranges, microwaves, coffee makers, etc.) should have key-operated lockout switches<sup>611</sup> to disable the appliance. If these and other appliances, such as refrigerators, have open handles that could be used as ligature attachment points, and they are in areas where patients have unsupervised access to them, provisions should be made to close them off with overhead coiling doors or other means.

- i. Patient access to coffee should be carefully considered in each facility's Environmental Safety Risk Assessment (ESRA). If access to this (and other potentially scalding liquids) is allowed, an insulated plastic dispenser should be located so it is readily observable by staff. Glass coffee pots should never be available to patients.
- ii. All garbage disposal units should have a key-operated lockout switch<sup>611</sup> to disable the device.
- iii. All receptacles located near sources of water, including sinks, as well as all patient-accessible receptacles must be GFCI-protected and Arc-fault protection, as required by applicable codes.



#### b. Television Set Enclosures (Typically Levels II and Level III only) -

Television sets should not be mounted on walls using exposed brackets because of the ligature risk this presents. Rather, all TV sets should be installed in built-in TV or media centers or manufactured tamper-resistant covers with sloped tops.<sup>290</sup> Some facilities prefer to also have an isolation switch that staff can control.

For maximum safety, the electrical outlet and cable TV outlet should be located inside the cover to keep the wires and cables away from patients.



## 4. Furnishings

The health care organization should select furniture appropriate for the patient population served and the location on the unit for which it is intended. Care should be taken to realize that it is not uncommon for unauthorized movement of furniture from a low-level risk area to a higher risk area of a unit to occur. This may result in unintended risks being created.

- a. **Seating** - Closed arms and legs on furniture that is weighted or is securely fixed in position may be preferred when consistent with the Environmental Safety Risk Assessment. High quality plastic chairs for use at tables may be acceptable. Lounge chairs with upholstery<sup>482</sup> that resemble typical residential furniture and meet the criteria above are generally preferred.
- b. **Tables**<sup>485</sup> are suggested to not have individual legs at the corners and be weighted or anchored in place to resist being thrown or stacked.
- c. **Bookcases and Cabinets** - Same as Baseline.



#480b



#482a



#485a

## 6. Plumbing Fixtures and Fittings

- a. **Toilet Fixtures** - Not permitted in Level III areas
- b. **Sinks** – Standard stainless-steel sinks may be permitted if that is consistent with the organization’s Environmental Safety Risk Assessment, but caution is recommended.
- c. **Showers** - Level IV and V only
- d. **Faucets** - Standard goose-neck faucets and standard valve handles may be permitted if that is consistent with the organization’s Environmental Safety Risk Assessment, but caution is recommended. In Level III areas consideration is suggested to locating these sinks behind lockable doors or roll-down shutters that are closed and secured when staff are not present.
- e. **Flush Valves** - Level IV and V only
- f. **Medical Gases** - Level IV and V only
- g. **Diffusers, Registers and Grilles** - Standard grilles are NOT recommended in Level III areas. Grilles with “S” shaped vanes<sup>600</sup> are preferred.

### END OF LEVEL III SECTION

*This document is intended to represent leading current practices, in the opinion of the authors. It does not represent minimum acceptable conditions or establish a legal “standard of care” that facilities are required to follow.*

**Areas where patients spend a great deal of time alone with minimal or no supervision:**

## Level IV-a. Patient Rooms



Architect winning design competition: HDR, Omaha, NE - Photographer: VA Photo, Scott R. Snell

**All items shall be the same as Baseline with the following exceptions:**

### 1. Openings

#### a. Doors:

- i. **Patient Room Doors** continue to be one of the most frequently used items in suicide attempts in these facilities. This is verified in **TJC's** "Incidence and Method of Suicide" study dated July 2018.

Barricade resistant strategies discussed in the Baseline section are strongly suggested to be used in these locations.

*This document is intended to represent leading current practices, in the opinion of the authors. It does not represent minimum acceptable conditions or establish a legal "standard of care" that facilities are required to follow.*



- ii. **Abuse** - These doors also frequently receive abuse and use of the more durable synthetic faced doors<sup>25</sup> in these locations will help retain their appearance.

## b. Door Hardware:

- i. **Handles** on lock-sets are especially important on these doors. Careful consideration of the risks involved in compliance with the Environmental Safety Risk Assessment is strongly suggested.
- ii. **Hinges** need to be carefully coordinated with the barricade resistant solution selected and over-door-alarm system, if provided. These need to be thought of as an assembly, not separate parts that can be put together in any combination.
- iii. **Over-the-door alarms**<sup>150</sup> are strongly suggested for patient room to corridor doors. Since the building and life safety codes require these doors to be tight-fitting for smoke and other reasons, the top of these doors is one of the attachment points most frequently used in suicide attempts. The bottom of doors can also present a risk if the gator roll technique is attempted. One product will detect this also.
- iv. **Locks** - Some facilities have begun to address the desire of some patients to lock themselves in their rooms to avoid unwanted entrance by other patients. The challenges with this are to provide individual security for the patient without restricting staff access to the room. Options include lock-sets with specialized locking functions and ligature-resistant turnpieces<sup>140</sup> that cannot be held from inside the door to resist a key being turned to unlock the door. A cylinder protector<sup>141</sup> to cover the lock cylinder on the corridor side of the door resists attempts to insert objects in the key-way. Card access technology is also available to control these locks.



#25a



#150a



#140



#141a

- c. **Windows:** – Advances in different types of safety glass make it worthwhile to consult an expert for advice for a specific project. The height above the ground, patient population, and many other factors should be taken into account in choosing these materials. Comply with the FGI Guidelines and all applicable codes and regulations for glazing, frame installation and operable sash.

If replacing windows presents a prohibitive cost in remodeling work, a security screen with a very sturdy steel frame<sup>80</sup> designed to resist deflection and equipped with multiple key locks and a heavy-gauge stainless steel screen fabric<sup>81</sup> may be used. These are functional and secure but create an “institutional” appearance and can be defaced by writing obscene words with toothpaste (or other material). Patients have also been known to use the rough surface of the screen fabric to abrade their skin

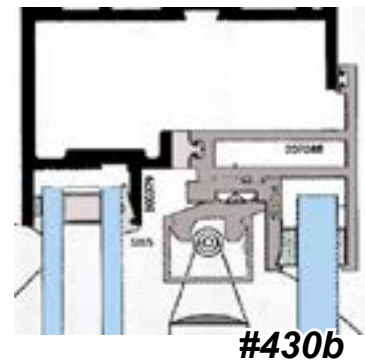

i. **Exterior Windows** - Mini- blinds<sup>430</sup> or roller blinds<sup>440</sup> behind safety glazing is strongly suggested for these rooms. Ligature resistant control of the blinds can either be by staff only or by both patients and staff as indicated by the Environmental Safety Risk Assessment.

ii. **Interior Windows** – The provision of view windows between patient rooms and corridors is usually discouraged for patient privacy reasons. The use of windows (either in doors or walls) as a method of performing routine patient checks at night is discouraged because it is often very difficult to observe the patient sufficiently. If these windows are provided, it is strongly suggested that they have either mini-blinds<sup>220</sup> between Security glass or glass that can be made opaque electrically.<sup>221</sup> Either type of control is preferred to be by staff only to restrict patients’ ability to peek in on other patients.



iii. **Operable Windows** – These are not usually required in patient rooms but may be provided if desired by using products that reduce the risk of elopement and passing of contraband<sup>434</sup> (if on the ground floor).



d. **Glazing** – Security glazing<sup>200</sup> is strongly suggested for these rooms.

e. **Window Coverings** – See Baseline

## 2. Finishes

a. **Walls** – Impact and/or abrasion-resistant gypsum board<sup>230</sup> installed on minimum 20-gauge metal studs spaced no more than 16 inches on center; paint finish preferred. Sound-

attenuating gypsum board<sup>232</sup> may also be used on walls if approved by the manufacturer for use in behavioral health applications.

- b. Ceilings – The FGI Guidelines** currently require “monolithic” ceilings in all patient bedrooms, bathrooms, bathing facilities and seclusion rooms. Their definition of this term virtually requires the use of solid gypsum board<sup>230, 232</sup> ceilings.

These monolithic ceilings are suggested to have key-lockable access panels<sup>30</sup> that fit tightly to their frames. Larger sizes of these panels, may require tamper-resistant screws in the corners or along the sides of the panels. Pick-resistant caulk may be needed if the flanges of these panels do not fit tightly to the ceiling or wall surface.



#30b

Other tamper-resistant systems<sup>239</sup> discussed in Baseline section do not appear to meet this definition.

- c. Wall Base** - See Baseline
- d. Flooring** – See Baseline: If some patients are prone to urinate on the floor, provide some rooms with seamless epoxy<sup>250</sup> or sheet vinyl flooring with an integral cove base. Metal or plastic strips should not be applied at the top edge of the base. Use of a system that eliminates the need for trim strips<sup>250c</sup> is recommended.
- e. Special Wall Surfacing** – Wall protection panels<sup>320</sup> are sometimes used in these areas, but the use of plastic or metal trim strips are strongly discouraged.

### 3. Specialties

- a. Cubicle Curtains and Tracks** – These are not recommended for use in behavioral health facilities because of the risk they present. If non-ambulatory patients with co-existing medical conditions are being treated on these units, it is recommended they be assigned to single-patient rooms.

## 4. Furnishings

### a. Seating:

- i. **Desk chairs** are preferred to be lightweight<sup>481</sup> or ballasted<sup>480</sup> as discussed in Baseline Considerations.
- ii. **Stools**<sup>479</sup> that are specially designed for use in behavioral health units are also available.



#480b

### b. Furniture:

- i. **Sturdy wood, thermoplastic, or composite furniture should be bolted to the floor or walls whenever possible.** Care must be taken to assure the furniture will withstand abuse, will not provide opportunities for hiding contraband, does not have joints that will allow penetration of liquids such as urine, and will resist being disassembled to provide patients with weapons.



#479a

Doors should not be provided on cabinets because they can be used by patients as ligature attachment points. Similarly drawers should not be provided because they can be used as ligature attachment points, removed by patients and broken to use as weapons.

All upholstery and foam used in furniture and mattresses should have flame-spread ratings that comply with the requirements of NFPA 101: *Life Safety Code*, Section 10.3.

### ii. Beds

- **Non-Adjustable Platform Beds**<sup>493</sup> – Beds without wire springs or storage drawers are preferred. These beds should be securely anchored in place to prevent patients from using them to barricade the door. If a portable lifting device will be used, beds are available with an opening underneath to accommodate the legs of the lift.<sup>494</sup> Portable lifts can also be accommodated by placing an existing platform bed on a specially designed riser; this arrangement also reduces the amount of bending over staff need to do to work with the patient.<sup>494b</sup>



#495



#493f

- **Mattresses for Platform Beds**<sup>492</sup> – These should be specifically designed for use in behavioral health facilities and be resistant to abuse and contamination.



#492e

- **Bedding**<sup>491</sup> - If bedding other than standard sheets are indicated by the Environmental Safety Risk Assessment for some patients, one piece durable products are available,

- **Electric Hospital Beds** – If electrically operable beds are needed for patients with co-existing medical issues or to reduce risk of staff injuries, beds that are specifically marketed for use on behavioral health units<sup>490</sup> should be used rather than standard electrically adjustable hospital beds. These specialty beds will sense obstructions and reverse direction and have lockout features for the controls, reduced-length cords, and other tamper-resistant features. However, they do have significant ligature attachment point risks with the guard rails, headboard, foot board and allow access to many hazards beneath the bed.



#491a

- **If existing electrically operable beds** must be used for financial reasons, use only beds that require a constant pressure on a switch located on the bed rail (not a remote-control device or paddle that can be placed on the floor). Also, provide a key lockout switch<sup>611</sup> on the beds (or a removable pigtail) so only staff can operate the beds. All electrical cords should be secured and shortened. These beds also have significant ligature attachment risks as mentioned above.



#490d

- As for **other wheeled beds**, the wheels of electric hospital-type beds should be removed or rendered inoperable. It is further suggested that corridor doors to rooms with electrically operable beds be locked at all time the patient is not in the room to reduce the risk of other patients entering the room and harming themselves.

- iii. **Wardrobes** – Wardrobe units should not have doors and should have fixed (non-adjustable) shelves.<sup>496</sup> They should be securely anchored in place and have sloped tops. Wardrobes with clothes poles requiring hangers



#496



are discouraged because, although the bar can be made safe, the hangers present serious hazards. The **FGI Guidelines** no longer call for patient rooms to have accommodations for “hanging full-length clothing.” The average length of stay in many facilities is now in the 7-to-10-day range, and patients seldom come with clothing that needs to be hung up. The use of clothes hangers is not recommended.

- iv. Cabinets (Built-in)** – if provided, these are strongly suggested to have no doors or drawers and any shelves be securely anchored in place to resist both upward and downward force.
- One exception to not having cabinet doors may be cabinets to hold CPAP machines<sup>496c</sup> in some patient rooms if allowable by the facility’s Environmental Safety Risk Assessment. These have a slot to allow the tubing to exit the cabinet. Care is suggested in locating these and consideration of other patients who may have access to the tubing. It is suggested that if these are provided they be equipped with concealed hinges, key operated locks, ligature resistant pulls and be designed so the doors resist ligature attachment when closed and locked. The electrical receptacle to operate the machine is strongly suggested to be located inside this cabinet.



## 6. Plumbing Fixtures and Fittings

- a. Toilet Fixtures** - Levels IVb and Vb only
- b. Sinks** – Hand washing sinks are not required in Psychiatric Hospital patient rooms by the FGI Guidelines but toilet rooms are required to have sinks by the FGI Guidelines and are covered in Level IVb.
- c. Showers** - Levels IVb and V only
- d. Faucets** - Levels IVb and V only
- e. Flush Valves** - Levels IVb and V only
- f. Water Stations** – Levels II and III only

**g. Medical Gases** – These are not normally required for behavioral health units. If there is medical necessity or the outlets are a preexisting condition in remodeling projects, they are suggested to be covered with lockable panels<sup>590c</sup> as listed in Baseline above or panels attached with tamper-resistant screws. These covers should be removed or opened only to address the medical needs of the current patient and replaced when that patient is discharged or moved. Special care must be taken in semi-private rooms to assure that access to the medical gases does not present a safety risk to the other patient. Some manufacturers offer lockable covers for outlets. Cabinets that are large enough to enclose the devices attached to the outlets<sup>590b</sup> are preferred.



#590b



#590c

## 7. Heating, Ventilating & Air Conditioning (HVAC)

### a. Diffusers, Registers and Grilles:

- i. **Fully recessed vandal-resistant grilles** with S-shaped air passageways<sup>600</sup> are recommended for all ceiling and wall-mounted grilles. Perforated air grilles are not suggested for Level IV areas.
- ii. **HVAC Equipment** - In new construction or major remodeling projects, locate individual room HVAC equipment (such as fan/coil units) in an adjacent corridor or another location (e.g., an interstitial space) where they can be serviced without entering the patient room.
- iii. **HVAC Equipment** - If individual fan/coil-type units exist and must remain, they should be protected with vandal-resistant covers<sup>606</sup> the same as for corridors in all other Levels.

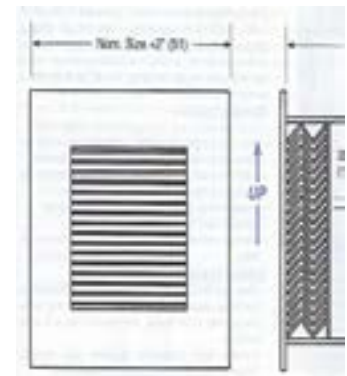

#600a

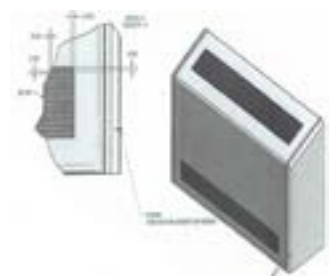

#606

**b. Thermostats** – See Baseline and as called for in the Environmental Safety Risk Assessment.

## 8. Electrical

### a. Electrical Devices:

- i. **New construction or major remodeling** - the **FGI Guidelines** require a dedicated circuit be provided for all electrical outlets in each patient room and bath. This will allow power to the outlets in a specific room to be turned off if necessary for a patient's safety. Control of each circuit should be located where only staff have access. Where this is not practical in an existing facility, a tamper-resistant temporary cover may be installed when necessary.
- ii. **All electrical switch and outlet cover plates** should be as discussed in Section A - Baseline Conditions.



#612c

### b. Light Fixtures –

- i. **Standard Fixture** - The standard general hospital practice of providing a 2'x4' light fixture directly over patient beds is seldom needed in behavioral health facilities because medical treatment is not provided in the patient beds and looking up into one is not very pleasant.
- ii. **LED Fixture** - The current preference is for using either wall or ceiling mounted narrow strip LED fixtures.<sup>620d</sup> An alternative can be round or oval vandal-resistant fixtures<sup>620k</sup> for general illumination. Many of these fixtures are now available with LED light sources and some are tunable to allow patients or staff to change the color or the light.
- iii. **Downlight** - Any downlights are suggested to have polycarbonate lenses.<sup>620h</sup>
- iv. **Small individual reading lights**<sup>624</sup> can be provided to give reading light near beds or adjacent to built-in bench seating areas or allow patients to turn on a small light to assist when getting up in the middle of the night.
- v. **Night Lights**<sup>639</sup> – are required by the **FGI Guidelines** in patient rooms and these are to be controlled from a location near the door to the room.



#620h



#624



#639a

## 9. Communications

- a. Telephone Sets** are not typically provided in behavioral health patient rooms.
- b. Nurse Calls** are not required in behavioral health patient rooms by the FGI Guidelines; however if they are provided, they are required to meet their standards and are suggested to have flush mounted push button activation.<sup>653</sup>

If cords are provided, it is recommended they be no longer than 6” and as lightweight as possible.

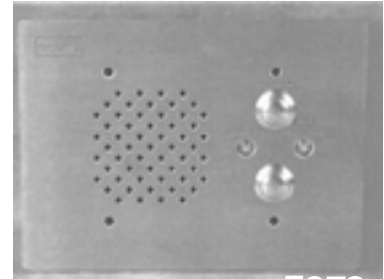

**#653**

**END OF LEVEL IV-a SECTION**

## Level IV-b. En-suite Patient Toilet Rooms:



Architect of Record - Davis Partnership, Denver, CO: Photographer - Paul Brokering Photography

*This document is intended to represent leading current practices, in the opinion of the authors. It does not represent minimum acceptable conditions or establish a legal "standard of care" that facilities are required to follow.*



**All items shall be the same as Baseline with the following exceptions:**

## 1. Openings

- a. Doors & Hardware** - The first question to address for patient toilet room doors is whether the facility ever has the need/desire to lock patients out of their bathrooms.
- i. Locking** - If there is a need to lock patients out of the bathroom, one of the following options may be provided:
- **Full Height Door** - full-size, tight fitting, out-swinging door mounted on a continuous hinge<sup>111</sup> with hospital tip and over-door alarm<sup>150</sup> is preferred. A full height door mounted on double acting continuous hinge<sup>113c</sup> may be acceptable in some conditions, however most AHJ require out-swinging patient toilet room door. A classroom function deadbolt that extends the bolt into the head of the door frame (with a ligature-resistant turn piece on the inside that will retract the bolt but not extend it<sup>143b</sup>), two flush pulls<sup>121</sup> mounted back to back (larger pulls<sup>121d</sup> available for ADA accessible rooms), and a roller,<sup>147</sup> ball<sup>146</sup> or magnetic<sup>148</sup> latch at the head should be installed along with a rubber fin with top fixing bracket<sup>473e</sup> mounted on the strike side of the frame.
  - **A sliding door**<sup>40g</sup> that is ligature resistant can eliminate issues with swinging door conflicts or floor space issues as long as there is wall surface for it to slide over in the open position. Ligature resistant pulls and locking hardware are available for this configuration. A frame assembly is now available for this system to assist with installation on existing openings.
- ii. Non-Locking** - If it is not necessary to lock patients out of their bathrooms, one of the following options may be provided:
- **Non-lockable doors** eliminate many of the hanging hazards associated with a typical door. Soft foam material doors attach with magnets<sup>470a</sup> and may be easily removed by staff for use as a shield against an attacking patient.



#113c

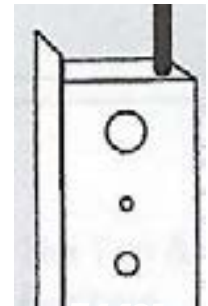

#143b



#473e



#40g

- **Door assemblies with sloped tops**<sup>473c</sup>, continuous hinges and rubber fins at the strike jamb and ligature resistant pulls are another option.
- **No Door** - Some facilities with single-patient rooms are electing to remove doors entirely from patient toilet rooms. The practicality of this depends on not having a clear sight line into the toilet room from the corridor door. This has proven to be unpopular with patients in some facilities due to the lack of privacy.



#470a

- iii. **Shower Openings - Doors** – No shower curtains or their tracks of any type (including those designated as “breakaway” and represented by their manufacturers as “safe for psychiatric hospitals”) are recommended for use in any patient-accessible areas, especially patient showers.

In new construction, showers are strongly encouraged to be designed to contain the spray within the compartment without the use of a curtain or door.

The use of foam doors<sup>470a</sup> or hard plastic doors<sup>473c</sup> mounted with a minimal gap between the bottom of the door and the floor may be used to reduce the amount of water that leaves the shower compartment.

The use of residential glass shower doors is specifically discouraged.



#473c

## 2. Finishes

- a. **Walls** – The following are suggested depending on the acuity of the patient population and the project budget:
- Synthetic wall protection panels**<sup>331</sup> (without trim pieces) or solid-surface sheet material
  - Ceramic or porcelain tile** in large pieces.
  - Gypsum board** that is impact-resistant and has mold and moisture-resistant facing<sup>230</sup> with epoxy paint.

**b. Ceiling** – Gypsum board with mold- and moisture-resistant facing<sup>230</sup> with epoxy paint is recommended.

**c. Wall Base** – See Baseline.

**d. Flooring** – One of the following slip-resistant products may be used depending on the acuity of the patient population and the Environmental Safety Risk Assessment :

**i. Seamless Epoxy Flooring<sup>250</sup>** – This flooring should have a slip-resistant finish and integral cove base and can be used in a shower. Do not use a metal or plastic strip at the top of the base as patients can remove it for use as a weapon.

**ii. Ceramic and Porcelain Tile** - Larger slip resistant tiles may be used (to reduce the number of joints) as long as the installation is maintained in good condition.

**iii. One-Piece Floor Units** – These units<sup>564</sup> provide a monolithic floor (European-style) for the entire patient toilet room that drains the shower to a central location. If used in conjunction with location of the shower enclosure and shower head, this unit can eliminate the need for shower curtains.

**iv. Solid-Surface Material Basins** – These are available with a trench drain<sup>567</sup> across the entire front opening of the stall, which not only helps keep water from getting into the room, but also makes the drain more difficult for patients to intentionally clog. Fiberglass shower stalls and floors are generally not durable enough.

**v. Prefabricated Bathrooms<sup>568</sup>** – These contain all finishes, fixtures, and accessories and can reduce construction time because they are shipped to the site ready to be connected to the utilities. Care must be taken for use of durable materials.

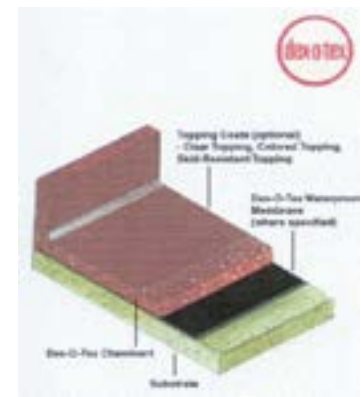

#250a



#567b



#568a

### 3. Specialties

#### a. Toilet Accessories –

**i. Robe Hooks** – Evaluate the risk of using these hooks. If they are required, they should be the collapsible type.<sup>350</sup>



#350e

- ii. **Towel Bars** – Use collapsible hooks<sup>350</sup> instead of towel bars for towels.
- iii. **Grab Bars** – Because some patients may be on medications that interfere with their equilibrium, grab bars for toilets and showers are recommended for all patient-accessible toilets. A self-draining bar<sup>332</sup> may be installed on a slight slope. These provide a high degree of safety and are also easy to clean and sanitize. If the wall surface behind the bar is not smooth and flat, provide pick-resistant sealant to the joint between the bar and the wall.
- iv. **Vertical Grab Bars** – In locations where vertical grab bars are required or desired, typical ligature-resistant bars mounted vertically can usually be grasped only from one side. A ligature-resistant grab bar specifically designed to be mounted vertically<sup>337</sup> that can be grasped from either side is available.
- v. **Soap Dishes** - These should not have handles and should be recessed. Soap dishes that can be installed from the front <sup>390a</sup> should be provided unless there is access to the chase behind the wall for installation
- vi. **Soap Dispensers** – Many facilities now use liquid or foam soap in patient areas, but the commonly used hard-plastic soap dispensers are problematic in that they are fairly easy to pull off the wall and break into sharp shards that can be used as weapons. At least one manufacturer now offers steel covers for their standard dispensers. Another solution is a dispenser made of solid-surface material<sup>391</sup> commonly used for counter tops that is relatively tamper-resistant. Some commercially available stainless steel dispensers are reasonably ligature-resistant.
- vii. **Toilet Paper Holders:**
- **Toilet paper holders**<sup>400</sup> that do not require a bar or tube to hold the paper allow for standard use of the roll of toilet paper without requiring everyone using the roll to handle it. They are available in recessed and surface mounted styles and some have no moving parts.
  - **Other toilet paper holders** use a bar(s) that pivot down<sup>400f,g</sup> when vertical pressure is imposed.



#332b



#337



#390a



#391b



#400b



#400f

viii. **Shelves** – Shelves to hold miscellaneous items are often requested in shower stalls and near wall-hung lavatories. A stainless-steel suicide-resistant shelf that is either surface-mounted<sup>371</sup> or recessed into the wall<sup>370</sup> may be considered for these applications. Front mounted recessed units are preferred unless access to the chase is provided.



#370a

ix. **Paper Towel Dispensers** – Paper towel dispensers are a concern in patient-accessible toilets because they typically are constructed of light-weight materials that can either be broken or bent to form sharp objects that may be used as weapons. Alternatives are as follows:

- Place a small stack of paper towels on a surface-mounted or recessed shelf.
- Provide a heavy-gauge, vandal-resistant dispenser.<sup>340b</sup>
- Install a heavy-duty secure cover<sup>340a</sup> over a standard-weight paper towel dispenser.
- Install a polycarbonate, vandal-resistant dispenser.<sup>340c</sup>



#340b



#340a

b. **Mirrors** – There are several options now available.

- Glass-laminated polycarbonate mirrors in ligature resistant wood frames offer an option with a residential appearance and are scratch resistant. (See also A.3.e.i)
- Polycarbonate mirrors with built-in lighting are attractive and non-institutional but are susceptible to scratching.
- Typical radius stainless steel-framed security mirrors<sup>360</sup> are available with polycarbonate, tempered glass, stainless steel, or chrome-plated steel reflective surfaces. Each has different durability and distortion characteristics. Some framed mirrors have a flat surface on top which may be a ligature attachment point.



#360a

## 6. Plumbing Fixtures and Fittings

a. **Toilet Fixtures** - Toilets used by behavioral health patients should be a floor-mounted, back water supply type rather than a wall-mounted fixture, which can be broken off its hangers and may present a ligature attachment risk.



#531a



These type fixtures are available in china, stainless steel and solid surface material. Where wall-hung toilets or floor mounted fixtures that do not fit tightly to the wall exist and replacing them is not practical, some facilities have had stainless steel or solid surface filler panels custom fabricated to fill the voids.

- i. **Movable seats** provide attachment points for ligatures, so their use should be considered carefully by each hospital. The solution is to use a fixture with an integral seat as suggested above<sup>534b</sup>. Some facilities feel this is too prison-like and choose to accept the risk of the movable seat. At the present time, TJC is allowing movable toilet sets in behavioral health facilities.
- ii. **China fixtures** themselves (both floor- and wall-mounted) can be broken into large, sharp shards. Toilet fixtures made of solid-surface material<sup>533</sup> and stainless steel<sup>534</sup> are available and are much more resistant to breakage. The stainless steel fixtures can be powder-coated for a less “institutional” appearance.
- iii. **Bariatric** - Toilet fixtures that manufacturers claim will support loads in excess of 2,000 pounds are available if needed for patients of size.<sup>536</sup>



#534b



#533



#536

## b. Sinks:

- i. **Solid Surface** - Typical commercial solid-surface counter tops with integral sinks offer a much less institutional appearance. They also provide a place for patients to set their toothbrushes, etc. Specialty vanity top-type lavatories<sup>542</sup> provide many of the same benefits.
- ii. **Wall-Hung Solid-Surface Lavatories** – Corner lavatories<sup>540</sup> make ligature attachment difficult and some come with the ADA required 18” space from the wall to the centerline of the drain and matching pipe enclosure.
- iii. If a **wall-hung fixture** is used that does not fit into a corner,<sup>541</sup> the optional filler panel is recommended to fill the space between the side of the fixture and an adjacent wall when there is one near the fixture. Stainless steel or high-impact polymer pipe covers designed for the lavatories that fit tightly to the bottom of the fixture should also be provided.



#540a



#541a

iv. **Lavatory Waste and Supply Piping** – All piping of this type must be enclosed so it is not accessible to patients.<sup>410</sup> Extreme care should be taken to trim the enclosing material so it fits tightly to the underside of the lavatory fixture to prevent the patient from using this space to hide contraband.



#410a

### c. Showers:

i. **Shower Heads** – These should be a ligature-resistant institutional type.<sup>550</sup> ADA Handicapped-accessible showers are required to have either a hand-held shower head or a second, lower head 48” above the floor. The hand-held shower head should be on a ligature-resistant, quick-disconnect fitting<sup>563b</sup> that allows removal of the head and attached hose when not in use. If a hook is provided to hold the hand-held shower head, it should be mounted on the part of the fitting that is removed when the hose is removed. A ligature resistant shower head with integral quick-disconnect fitting and internal diverter valve<sup>553a</sup> is available which reduces the clutter of individual items. Another option is to provide a lockable cabinet to house the hand-held head and valve.<sup>562</sup>



#563a

ii. **Shower Control Valves** - *Note:* Provide thermostatically limited hot water to prevent accidental or intentional scalding in all patient-accessible sinks and showers.

- **Single-knob mixing valves** that provide minimal opportunity for tying anything around them are preferred.<sup>552</sup> These give patients control of the water temperature and duration of flow. Some of these are claimed to be ADA-compliant by their manufacturers.
- If it is only necessary to **replace the valve handles** and the valve itself is working properly, use of a replacement valve handle<sup>552c</sup> that can be adapted to a variety of valves might be considered. *Note:* This may void any remaining warranty on the existing valve.
- A “**no-touch**” valve<sup>552e</sup> that appears to be ADA compliant is available. It utilizes infrared controls to give patients control of a range of water temperatures and the duration of flow.
- **One-piece shower assemblies** that contain shower heads, valves, and a recessed soap dishes<sup>560</sup> work



#552b



#560c

well for remodeling projects because they reduce the amount of repair needed for wall finishes. These are also available with a second head<sup>563c</sup> located 48” above the floor and a diverter valve if needed for ADA purposes.

**iii. Shower Drains** – That offer less opportunity for ligature attachment or patients abrading their skin<sup>565</sup> are preferred over more traditional drain grates.

**iv. Diverter Valve** – If a diverter valve is needed to change the water flow from the standard shower head to the ADA-required head, a ligature-resistant diverter valve<sup>555</sup> may be provided.

**d. Faucets - Lavatory and Sink Faucets and Valves** – Faucets and valves can provide attachment points for ligatures. A lavatory valve unit is now available that uses a shower valve fitted with a ligature-resistant handle<sup>574</sup> to allow patients to control the temperature (thermostatically limited to prevent scalding) and duration of the water flow. This valve can be used to replace the motion sensor activation of some faucets. Faucets are available in a variety of materials and configurations that range from push-button to motion sensor-activated.<sup>570</sup> Faucets with two push buttons allow patients some choice of water temperature and do not require electricity (either battery or line voltage) to operate. They also will not automatically turn on unexpectedly, which is disturbing to some patients.

**e. Flush Valves** – Toilet flush valves that are recessed in the wall<sup>580</sup> and activated by a push button<sup>581</sup> are preferred. Where this is not practical, the flush valve and all related pipes should be enclosed with a stainless steel<sup>585</sup> or plastic<sup>585b</sup> cover with a sloped top that incorporates a push-button activator for the valve. Sensor activation of flush valves is discouraged because they require electricity (either battery or line voltage) and may flush unexpectedly which can be disturbing to some patients.

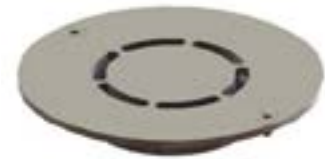

#565c



#570



#581b



#585a

## 7. Heating, Ventilation & Air Conditioning (HVAC)

- a. **Air Grilles** – Perforated air grilles are not suggested for Level IV areas. Grilles with “S” vanes are preferred. See Section A Baseline Conditions.

## 8. Electrical

### a. Electrical Devices:

- i. In new construction or major remodeling, the **FGI Guidelines** require a dedicated circuit be provided for all electrical outlets in each patient room and bath. This will allow power to the outlets in a specific room to be turned off if necessary for a patient’s safety. Control of each circuit should be located where only staff have access. Where this is not practical in an existing facility, a tamper-resistant temporary cover may be installed when necessary.
- ii. **All electrical switch and outlet cover plates** should be as discussed in Baseline.

- b. **Light Fixtures** – These fixtures require wet condition rating and are otherwise the same as Baseline.

## 9. Communications

- a. **Nurse Calls** – These are not required by the **FGI Guidelines**, but if they are provided, they must meet general hospital standards. In addition, flush mounted push-button activation is preferred.<sup>653</sup> In areas where falls may occur, it is recommended that a second push button located about 12” above the floor be provided below the one at normal mounting height. If pull cord activators are provided, the **FGI Guidelines** limit their length to a maximum of 6 inches in length.

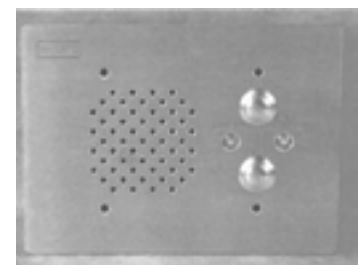

#653

### END OF LEVEL IV-b SECTION

## F. Level V:

**Areas where staff interact with newly admitted patients who present potential unknown risks or where patients may be in highly agitated condition, such as Admissions, and Seclusion/Restraint Suites:**

### Level V-a. Admissions:



*West Springs Hospital - Admissions Lobby*

Architect of Record - Davis Partnership, Denver, CO: Photographer - Paul Brokering Photography

### **All items shall be the same as Level IV with the following exceptions:**

If possible, the admissions function is preferred to not take place on an inpatient unit. At admission, unit staff members know very little about a new patient and his or her trigger points. A separate location for admission avoids disrupting either the unit or the new patient due to the agitation of either.

The Admission rooms should be pleasant, calming, quiet and welcoming; and should be minimally furnished (with a few loose pieces of furniture).

The room should be large enough to allow for several staff to physically manage the patient if necessary. If possible, the admitting staff member should not be in the room alone with a patient. After the admitting process is complete, the patient can be escorted to the unit. These precautions are particularly important for emergency admissions, which frequently occur at night and on weekends.

*This document is intended to represent leading current practices, in the opinion of the authors. It does not represent minimum acceptable conditions or establish a legal "standard of care" that facilities are required to follow.*



## 1. Openings

- a. Doors** - As stated above, all rooms patients will enter are suggested to have a barricade-resistant solution as discussed in Baseline.
- b. Windows:**
- Exterior – If exterior windows are present, they are suggested to comply with comments for Level IV above.
  - Interior - Provide a small (12”x12” or 4”x24”) view window in the door that can be controlled by staff<sup>220</sup> from outside the room to observe what is happening in the room when necessary and resist non-authorized individuals having visual access to the room.



## 4. Furnishings

**a. Cabinets (Built-in)** - Same as discussed in Baseline.

### b. Seating –

- The furniture arrangement is suggested to locate the patient’s and family member’s chair(s) so that when they are seated, they will not be between the staff member and the door to the room. *Refer to Diagram #1.*

Chairs<sup>482</sup> are preferred to be comfortable and fixed in place or heavyweight as discussed in Section A Baseline Concepts.

- Desk Seating for staff<sup>480</sup> is suggested to be a lightweight plastic chair in lieu of a standard desk chair which could be used as a weapon.



### b. Furniture:

- If a built-in desk or table is provided, it is preferred to be sturdy and firmly attached to the floor or walls and contain a lockable file drawer for forms and a lockable box drawer for pens, pencils, staplers, etc. All loose items should be kept in drawers and out of sight.
- The use of laptop or tablet computers in these rooms is preferable to minimize cords and wires that patients may



be able to access. If desktop computers are provided, they are suggested to be located so the patient cannot easily reach them.

## 8. Electrical

- a. **Light Fixtures** – Dimmable wall or ceiling washing light fixtures are suggested so that lower levels (and possibly more soothing color temperatures) are available to provide a less stimulating environment. See Baseline

## 9. Communications

- a. **Telephone Sets** – are suggested to be cordless phones to reduce the number of wires that may be available to patients. If standard telephones are provided, it is suggested that they be located as far away from patients as possible or in lockable cabinets.
- b. **Nurse Calls / Duress Alarms** If a personal duress alarm system<sup>650</sup> is not present, an emergency call button<sup>654</sup> for use by staff is strongly suggested to be provided so staff may summon additional staff members if necessary.



## 10. Electronic Safety

- a. **Metal Detectors**<sup>660</sup> – may be provided in the Admissions area to assist with screening incoming patients for contraband. See Baseline



**END OF LEVEL V-a SECTION**

## Level V-b. Seclusion Suites and Restraint Suites



### All items shall be the same as Level IV with the following exceptions:

Seclusion Rooms and Restraint Rooms are very similar in design and construction with the size and furniture being the two main differentiating features. The ***FGI Guidelines*** require Seclusion Rooms to be a minimum of 60 square feet in floor area and Restraint rooms to be a minimum of 80 square feet in floor area. They should be no less than 7 feet wide and no greater than 11 feet long (*11-ft 2018 FGI and 12-ft 2022 FGI*) to avoid providing enough space for a patient to get a running start at the opposite wall. They should be designed to minimize blind spots where patients cannot be observed by staff without entering the room and outside corners are to be avoided, where possible. A minimum ceiling height of 9 feet is preferred.

It is strongly suggested that one room not be used for both secluding and restraining patients unless the loops for attaching the restraint straps are removed before the room is used for secluding a patient. The Environmental Safety Risk Assessment should address all aspects of seclusion and restraint in detail.

*This document is intended to represent leading current practices, in the opinion of the authors. It does not represent minimum acceptable conditions or establish a legal "standard of care" that facilities are required to follow.*

The distance of the seclusion room from the nurse station needs to be considered. The goal is to avoid excessive distance so staff can be readily available as needed. The seclusion room door should swing out of the room and open directly into an anteroom to separate these activities from other patients and give the patient access to a toilet without entering the corridor

## 1. Openings

- a. Doors** - Heavy-duty, commercial-grade steel doors with a minimum clear width of 3'-8" (usually requires nominal 4'-0" wide doors) that are hinged to swing out of the room. A polycarbonate<sup>201</sup> view window that does not exceed 100 square inches is strongly suggested to allow staff to observe the patient and determine the location of the patient before opening the door. The height of the window should allow shorter staff members to see into the room.
- b. Door Hardware:**
- i. **Exposed door hardware** is typically not provided on the inside face of these doors.
  - ii. **The seclusion room door** is preferred to have three-point latching with *manual activation of a single lever* required to engage all three bolts.<sup>160</sup> This operation greatly reduces the risk of a staff becoming locked in the room with a patient. Hardware that automatically latches when the door is closed and latched can result in staff being locked in the room with the patient.



#160d

**c. Windows:**

- i. **Exterior** – If exterior windows are present, they are suggested to be a minimum of 1/2" thick polycarbonate and have either mini-blinds or roller blinds that have motorized operation controllable from the Ante Room.
- ii. **Interior** – See comments on view window in the door above. Other interior windows in these rooms are discouraged to help avoid over-stimulation of patients.



#270a

## 2. Finishes

**a. Walls:**

- i. **Padded wall finish** is often provided which has either a Kevlar-facing or heavy vinyl facing and 1 1/2" thick foam backing.<sup>270</sup>

*This document is intended to represent leading current practices, in the opinion of the authors. It does not represent minimum acceptable conditions or establish a legal "standard of care" that facilities are required to follow.*

- ii. **Unpadded** - Impact-resistant gypsum board<sup>230</sup> over 3/4" plywood (or 25 gauge sheet metal which stiffens the wall, is easily cut and does not require wider door frames) on minimum 20-gauge metal studs at 16" on center with high performance finish<sup>280</sup> are minimum recommendations.
- b. Ceilings** – Impact-resistant and/or abrasion-resistant gypsum board<sup>230, 231</sup> painted with high performance finish<sup>280</sup> at 9'-0" minimum height is preferred.
- c. Wall Base:**
- i. **Unpadded** – Use of a separate base material is not recommended in these rooms. If painted, exposed gypsum board finish is provided; it is preferred that it be extended to the floor and a pick-resistant caulk joint be provided at the floor. A painted stripe that is 4" or 6" high may be provided to help hide scuffing and marking on the wall.
  - ii. **Padded** – No base is typically provided, the padding extends to the top of the flooring.
- d. Flooring** – Provide continuous sheet vinyl with foam backing and heat-welded seams<sup>272</sup> or padded flooring to match wall padding.

### 3. Specialties

- a. Mirrors and Domes – Observation Mirror** – Install a convex mirror<sup>420</sup> at the ceiling in the corner of the room opposite the seclusion room door. Make sure the mirror can be seen when viewing it from the window in the door. This mirror will give staff a full view of the room prior to opening the door. Care shall be taken to assure the attachment is secure so the patient cannot remove it and have a weapon and the perimeter is sealed with pick-resistant caulk.

### 4. Furnishings

No furniture is typically provided in Seclusion rooms and Restraint Rooms other than the following:

**a. Furniture:**

- i. **Seclusion rooms** are suggested to have only a behavioral health care mattress<sup>492</sup> on the floor or a special seclusion room bed.<sup>493a</sup> These beds should not have



**#492**



**#493a**

*This document is intended to represent leading current practices, in the opinion of the authors. It does not represent minimum acceptable conditions or establish a legal "standard of care" that facilities are required to follow.*



exposed loops to which mechanical restraints may be attached because these may be used as ligature attachment points for secluded patients.

- ii. **Restraint rooms** are suggested to have special beds with loops for attachment of restraint straps.<sup>497</sup> These beds are typically anchored in place and positioned to allow space for access on at least three sides, if not all four sides.
- iii. **Seclusion and Restraint Room** - If a room will be used for patients that are both in restraints and in seclusion (without restraints), there are several beds available that have restraint attachment loops that may be quickly and easily removed.<sup>498</sup>

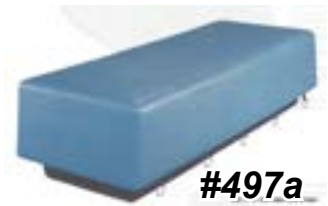

#497a



#498a

## 5. Fire Suppression

- a. **Fire Sprinkler Heads** - Institutional Type – Same as for Level IV.

## 6. Plumbing Fixtures and Fittings

- a. **Same as those in Level IV-B** except that toilet fixtures of Powder-coated stainless-steel fixtures<sup>534</sup> or solid surface material<sup>533</sup> are preferred by some facilities.

**NOTE:** All plumbing fixtures intended for use by patients in this area are required by the FGI Guidelines to be in a separate room that is accessed via an Ante Room from the Seclusion/Restraint Room.

## 7. Heating, Ventilation & Air Conditioning (HVAC)

- a. **Diffusers, Registers and Grilles HVAC grilles** - Fully recessed, vandal-resistant grilles with S-shaped air passageways<sup>600</sup>
- b. **Thermostats** – These are preferred to be a digital type with control mounted on the wall in the anteroom and sensor in the return air duct serving the room.

## 8. Electrical

- a. **Electrical Devices.** No electrical outlets, switches, thermostats, blank cover plates, or similar devices are permitted by the FGI Guidelines inside seclusion rooms.
- b. **Light Fixtures. Light Fixtures** – Fully recessed, moisture-resistant, vandal-resistant light fixtures<sup>620i</sup> installed in the ceiling are recommended. Dimmable wall or ceiling washing light fixtures are suggested so that lower levels (and possibly more soothing colors) are available to provide a less stimulating environment.

## 9. Communications

- a. **Telephone Sets** - None allowed.
- b. **Nurse Calls / Duress Alarms** – None allowed, it is typical that a staff member is assigned to continuously observe the patient in these rooms. A staff assist call button<sup>653</sup> mounted in the Anteroom may be required by the FGI Guidelines

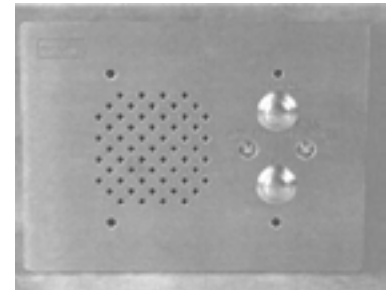

**#653**

**END OF LEVEL V-b SECTION**

## Summary

Thoughtful consideration of these design elements and materials by design team members and hospital staff can result in a very aesthetically pleasing environment that will enhance the treatment process and help maximize safety for patients, staff, and visitors. It is strongly recommended that wall-hung lavatories, 2'x4' fluorescent light fixtures, paddle-handle door hardware, and many other items typically found in general hospitals **NOT** be used in behavioral and mental health facilities. The reasons these are used in general hospitals typically do not exist in behavioral and mental health care units. Their elimination will significantly reduce the institutional character of behavioral and mental health facilities without decreasing patient or staff safety.

As stated in the introduction, this document is intended to represent leading current practices and does not establish minimum standards for behavioral health facilities or represent requirements of codes or regulatory agencies. No product or built environment is entirely without risk.

The authors' desire is that hospital staff and their design teams will use this information to start conversations about what is the best solution for each individual facility's patients and staff.

For the purposes of this document, the Author has designated the needs of the Environmental Safety Risk Assessment **Level III** spaces to be defined as a "Baseline Methodology" for the conditions in all areas where behavioral and mental health patients will have access, both supervised and un-supervised.

As stated above, we consider these to be the "baseline" for a starting point or basis for comparison informed by leading practice conditions. TJC, FGI and other codes and regulatory bodies may be accepting of less stringent environment of care conditions, as the behavioral and mental health industry finds acceptable for organizations providing these services. This baseline is adjusted up or down for the levels of concern in the environmental safety risk assessment matrix as discussed in the Baseline Section.

### END OF ENVIRONMENTAL SAFETY RISK ASSESSMENT LEVEL DISCUSSION

*This document is intended to represent leading current practices, in the opinion of the authors. It does not represent minimum acceptable conditions or establish a legal "standard of care" that facilities are required to follow.*

## Appendix Index

<b><u>01 00 00 – GENERAL REQUIREMENTS</u></b>	<b><u>21 00 00 - FIRE SUPPRESSION</u></b>
01 00 01 – Trash Receptacle Liner . . . . . A2	21 13 13 - Fire Suppression Sprinkler Systems . . . . . A55
<b><u>07 00 00 – THERMAL &amp; MOISTURE PROTECTION</u></b>	<b><u>22 43 00 – PLUMBING FIXTURES</u></b>
07 92 00 – Joint Sealants . . . . . A2	22 43 13 – Healthcare Water Closets . . . . . A56
<b><u>08 00 00 - OPENINGS</u></b>	22 43 16 – Healthcare Sinks . . . . . A57
08 10 00 – Doors and Frames . . . . . A3	22 43 19 – Healthcare Bathtubs and Showers. . . . . A58
08 31 13 – Access Doors . . . . . A4	22 43 23 – Shower Receptors and Basins. . . . . A61
08 34 00 – Special Function Doors . . . . . A4	22 43 39 – Healthcare Faucets . . . . . A62
08 51 13 – Aluminum Windows . . . . . A7	22 43 43 – Plumbing Fixture Flushometers . . . . . A64
08 56 56 – Security Window Screens . . . . . A8	22 47 00 – Water Station Water Coolers. . . . . A66
08 71 00 – Door Hardware. . . . . A8	22 60 00 – Gas and Vacuum Systems . . . . . A67
08 87 53 – Security Films . . . . . A19	<b><u>23 00 00 – HEATING, VENTILATING &amp; HVAC</u></b>
08 88 53 – Security Glazing . . . . . A19	23 37 13 – Diffusers, Registers and Grilles . . . . . A68
<b><u>09 00 00 – FINISHES</u></b>	<b><u>26 00 00 - ELECTRICAL</u></b>
09 21 16 – Gypsum Board . . . . . A22	26 27 26 – Electrical Devices . . . . . A71
09 50 00 – Ceilings . . . . . A24	26 51 00 – Interior Lighting . . . . . A72
09 65 13 – Resilient Base . . . . . A24	26 53 00 – Exit Signs . . . . . A75
09 65 16 – Resilient Flooring . . . . . A25	26 55 53 – Security Lighting . . . . . A76
09 67 00 – Fluid-Applied Flooring . . . . . A25	<b><u>27 00 00 – COMMUNICATION</u></b>
09 68 16 – Sheet Carpeting . . . . . A26	27 32 13 – Telephone Sets. . . . . A76
09 77 00 – Special Wall Surfacing . . . . . A26	27 52 23 – Nurse Call/Code Blue Systems . . . . . A77
09 96 13 – Abrasion Resistant Coatings. . . . . A27	<b><u>28 00 00 – ELECTRONIC SAFETY &amp; SECURITY</u></b>
<b><u>10 00 00 – SPECIALTIES</u></b>	28 40 00 – Electronic Monitoring and Control . . . . . A78
10 12 00 – Display Cases . . . . . A27	<b><u>32 00 00 – EXTERIOR IMPROVEMENTS</u></b>
10 14 00 – Signage . . . . . A28	32 31 13 – Security Fencing . . . . . A78
10 26 16.16 – Protective Corridor Handrails . . . . . A29	
10 26 23 – Protective Wall Covering. . . . . A29	
10 28 13 – Security Toilet Accessories . . . . . A30	
10 86 00 – Security Mirrors and Domes . . . . . A38	
<b><u>12 00 00 – FURNISHINGS.</u></b>	
12 21 13 – Horizontal Louver Blinds . . . . . A38	
12 21 33 – Roll-Down Blinds. . . . . A40	
12 35 70 – Healthcare Case Work . . . . . A40	
12 44 16 – Shower Doors . . . . . A41	
12 46 23 – Decorative Crafts . . . . . A43	
12 52 70 – Healthcare Seating. . . . . A44	
12 56 70 – Healthcare Furniture . . . . . A49	
12 93 43 – Site Furnishings - Seating and Tables A55	

*Inclusion or exclusion of a product does not indicate endorsement or disapproval of that product, nor does it suggest that any product is free of risk. All products must be in compliance with the organization's Environmental Safety Risk Assessment for each location.*

## 01 00 00 – General

### 01 00 01 – Trash Receptacle Liner

- 1a. Trash receptacle liner – paper

**Sani-liner®**

Wisconsin Converting  
Green Bay, WI  
920-593-8297

[www.wisconsinconverting.com](http://www.wisconsinconverting.com)



#1a

- 1c. Trash receptacle liner – paper

**Psych-Select-Bag™**

Dano Group  
Stamford, CT  
800-348-3266

[www.danoinc.com](http://www.danoinc.com)



#1c

## 07 00 00 – Thermal and Moisture Protection

### 07 92 00 – Joint Sealants

- 10a. Sound and Smoke Seals – Breakaway

**Cush'N'Seal w/breakaway anti-ligature option**

Door and Hardware Systems, Inc.  
Rochester, NY  
585-235-8543

[www.dhsi-seal.com](http://www.dhsi-seal.com)

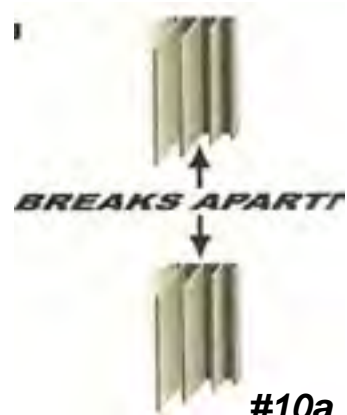

#10a

- 10b. Sound and smoke seals – breakaway

**Ligature-resistant Zag option**

Zero International – Allegion  
Indianapolis, IN  
877-671-7011

[www.zerointernational.com](http://www.zerointernational.com)



#10b

- 10c. Sound and smoke/fire seals – breakaway

**Adhesive gaskets - perforated**

Pemko Manufacturing Company  
Memphis, TN  
800-824-3018

[www.pemko.com](http://www.pemko.com)

*Inclusion or exclusion of a product does not indicate endorsement or disapproval of that product, nor does it suggest that any product is free of risk. All products must be in compliance with the organization's Environmental Safety Risk Assessment for each location.*



20a. Pick-resistant caulk

**Dynaflex™ SC**

Pecora Corporation  
Harleysville, PA  
800-523-6688  
[www.pecora.com](http://www.pecora.com)

20b. Pick-resistant caulk

**Everseal # SB-190**

Surebond  
St. Charles. IL 60174  
877-843-1818  
[www.surebond.com](http://www.surebond.com)

20c. Pick-resistant caulk

**MasterSeal® #CR 190**

BASF Construction Chemicals  
Shakopee, MN 55379  
800-243-6739  
[www.master-builders-solutions.basf.us](http://www.master-builders-solutions.basf.us)



#20b

## 08 00 00 - OPENINGS

### 08 10 00 – Doors and Frames

25a. Synthetic faced door

**Acrovyn® Doors**

Construction Specialties  
Lebanon, NJ 08833  
800-972-7214  
[www.c-sgroup.com](http://www.c-sgroup.com)

25b. Synthetic-faced door-

**Thermal-Fused Doors**

ASSA ABLOY Door Group  
c/o Maiman  
Springfield. MO 65803  
417-616-8234  
[www.assaabloywooddoors.com](http://www.assaabloywooddoors.com)



#25a



#25b

*Inclusion or exclusion of a product does not indicate endorsement or disapproval of that product, nor does it suggest that any product is free of risk. All products must be in compliance with the organization's Environmental Safety Risk Assessment for each location.*

**08 31 13 – Access Doors**

30.a Access panel – lockable

**SP Steel Security Panel with mortise deadbolt prep**

J. L. Industries, Inc.  
 Bloomington, MN 55435  
 800-554-6077  
[www.jlindustries.com](http://www.jlindustries.com)



30.b Access panel – lockable

**Security Access Panel with tamper resistant latches & rounded corners**

Weizel Security  
 800-308-3627  
[www.securingshospitals.com](http://www.securingshospitals.com)



**08 34 00 – Special Function Doors**

40a. Patient toilet door

**Wanford En-Suite Bathroom Door**

Safehinge-Primera  
 UK  
 0330-058-0988  
[www.safehingeprimera.com](http://www.safehingeprimera.com)

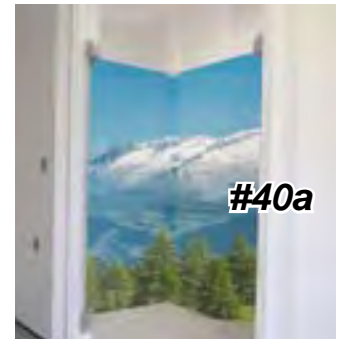

40b. Patient toilet door

**En-Suite Patient Bathroom Door w/ Shower Door**

**Option: #SHDUS02**

Kingsway Group USA  
 Royal Oak, MI 48073  
 800-783-7980  
[www.kingswaygroupusa.com](http://www.kingswaygroupusa.com)

NOTE: Hinge only, see Item 111g; Rubber fin only, see item 473e



*Inclusion or exclusion of a product does not indicate endorsement or disapproval of that product, nor does it suggest that any product is free of risk. All products must be in compliance with the organization's Environmental Safety Risk Assessment for each location.*

## 40c. Patient Toilet Door

**Ligature Resistant Sliding Door System with Frame**

Accurate Lock and Hardware

Stamford, CT 06902

203-348-8865

[www accuratelockandhardware.com](http://www accuratelockandhardware.com)

## 40d. Patient toilet door

**Sentinel Event Reduction Door**

Norva Plastics, Inc.

Norfolk, VA 23508

800-826-0758

[www.norvaplastics.com](http://www.norvaplastics.com)

## 40e. Patient toilet door

**Soft Suicide Prevention Door (SSPD) or Kennon Door 2.0**

Kennon Products, Inc.

Sheridan, WY 82801

307-674-6498

[www.suicideproofing.com](http://www.suicideproofing.com)

## 40f. Patient toilet door

**SafeDoor**

Norix Group, Inc.

West Chicago, IL 60185

800-234-4900

[www.norix.com](http://www.norix.com)

*Inclusion or exclusion of a product does not indicate endorsement or disapproval of that product, nor does it suggest that any product is free of risk. All products must be in compliance with the organization's Environmental Safety Risk Assessment for each location.*

## 44b. Wicket doors

**Acrovyn® Barrier-Resistant Doors**

Construction Specialties  
 Lebanon, NJ 08833  
 800-972-7214  
[www.c-sgroup.com](http://www.c-sgroup.com)

## 44c. Wicket doors

**Behavioral Health Series Patient Room Access Door**

ASSA ABLOY Door Security Solutions  
 New Haven, CT 06511  
 800-377-3948  
[www.assaabloydss.com](http://www.assaabloydss.com)



#44c

## 44d. Wicket doors

**Wicket Door (Wood Doors)**

Marshfield Door Systems  
 Marshfield, WI 54449  
 800-869-3667  
[www.marshfielddoors.com](http://www.marshfielddoors.com)

## 44e. Wicket doors

**GCD-EC Flush Wicket Door with structural composite lumber core**

Graham Wood Door  
 Mason City, Iowa 50401  
 641-423-2444  
[www.grahamdoors.com](http://www.grahamdoors.com)



## 47a. Security sidelight

**Security Sidelite Unit**

Curries Company  
 Mason City, IA 50401  
 641-423-1334  
[www.curries.com](http://www.curries.com)

## 47b. Security sidelight

**Security SideLite Unit**

Ceco Door  
 Milan, TN 38358  
[www.cecodoor.com](http://www.cecodoor.com)



#47b

*Inclusion or exclusion of a product does not indicate endorsement or disapproval of that product, nor does it suggest that any product is free of risk. All products must be in compliance with the organization's Environmental Safety Risk Assessment for each location.*

50. Access panel - lockable

**SP Steel Security Panel with mortise deadbold prep**

J.L. Industries, Inc.  
4450 West 78th Street Circle  
Bloomington, MN 55435  
800-554-6077  
[www.jlindustries.com](http://www.jlindustries.com)

**08 51 13 – Aluminum Windows**

60a. Aluminum window with integral blind

**2450 Series Storefront with hinged sash and integral blind**

Manko Window Systems, Inc.  
Manhattan, KS 66502  
800-642-1488  
[www.mankowindows.com](http://www.mankowindows.com)

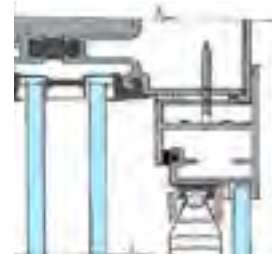

#60a

60b. Aluminum window with integral blind

**2187-DT Psychiatric Windows with integral blind**

Wausau Window and Wall Systems  
Wausau, WI 54401  
877-678-2983  
[www.wausauwindow.com](http://www.wausauwindow.com)



#60b

60c. Aluminum window with integral blind - removable

**SS-5100 Medium-Security Mental Health Security Window**

Sherwood Windows Group  
Toronto, Ontario M9W 5E3  
Canada  
800-770-5256  
[www.sherwoodwindows.com](http://www.sherwoodwindows.com)



#61a

61a. Exterior windows - ventilation

**Safevent Windows**

Britplas  
Woolston, Warrington WA1 4RW  
England  
+44-1925-824317  
[www.britplas.com](http://www.britplas.com)

*Inclusion or exclusion of a product does not indicate endorsement or disapproval of that product, nor does it suggest that any product is free of risk. All products must be in compliance with the organization's Environmental Safety Risk Assessment for each location.*



61b. Exterior windows - ventilation

**SW-6300 Operable Security Window**

Sherwood Windows Group  
Toronto, Ontario M9W 5E3  
Canada  
800-770-5256  
[www.sherwoodwindows.com](http://www.sherwoodwindows.com)



#61c

61c. Exterior windows - ventilation

**512 Ventrow Ventilator**

Kawneer North America  
Norcross, GA 30092  
770-449-5555  
[www.kawneer.com](http://www.kawneer.com)

## 08 56 56 – Security Window Screens

80. Security screens

**Security Screens**

Kane Innovations  
Erie, PA 16506  
800-773-2439  
[www.kanescreens.com](http://www.kanescreens.com)



#80

## 08 71 00 – Door Hardware

100a. Door closer

**Concealed closer #2010 Series**

LCN  
Princeton, IL 61356-0100  
877-671-7011  
[us.allegion.com/brands/lcn/Pages/default.aspx](http://us.allegion.com/brands/lcn/Pages/default.aspx)



#100a

100b. Door closer

**High-security track closer #4510T SMOOTHIE® Series**

LCN  
121 West Railroad Avenue  
Princeton, IL 61356-0100  
877-671-7011  
[us.allegion.com/brands/lcn/Pages/default.aspx](http://us.allegion.com/brands/lcn/Pages/default.aspx)

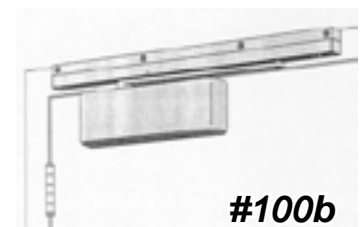

#100b

*Inclusion or exclusion of a product does not indicate endorsement or disapproval of that product, nor does it suggest that any product is free of risk. All products must be in compliance with the organization's Environmental Safety Risk Assessment for each location.*

101. Electrically controlled door closer

**Fire/Life Safety Series HSA Sentronic Electrically Controlled Closer/Holder**

LCN

P.O. Box 100

Princeton, IL. 61356-0100

815-875-3111

[us.allegion.com/brands/lcn/Pages/default.aspx](http://us.allegion.com/brands/lcn/Pages/default.aspx)



**#101**

109. Electric-release concealed deadbolts

**ELECTRATM concealed vertical rod latching lever locksets**

Securitech Group, Inc.

Maspeth, NY 11378

800-622-5625

[www.securitech.com](http://www.securitech.com)



**#110**

110. Electromagnetic lock

**Electromagnetic Locks**

DynaLock Corporation

Bristol, CT 06010

877-396-2562

[www.dynalock.com](http://www.dynalock.com)



**#111a**

111a. Continuous hinges – gear type with hospital tip

**780-Series Roton Hinges**

Hager Companies

St. Louis, MO 63104

800-325-9995

[www.hagerco.com/Product-Listing.aspx?CatID=152&SubCatID=189](http://www.hagerco.com/Product-Listing.aspx?CatID=152&SubCatID=189)



**#111b**

111b. Continuous hinges – gear type with hospital tip

**112HD Concealed Continuous Hinge**

Ives

Indianapolis, IN 46219

877-671-7011

[us.allegion.com](http://us.allegion.com)

111c. Continuous hinges – gear type with hospital tip  
**825-S22 SR™ SR824-S22 SafeSupport Continuous Gear Hinge**

Weizel Security

800-308-3627

[www.securingshospitals.com](http://www.securingshospitals.com)

111e. Continuous hinges – gear type with hospital tip  
**Continuous Geared Hinge # KG200**

Kingsway Group USA

Royal Oak, MI 48073

800-783-7980

[www.kingswaygroupusa.com](http://www.kingswaygroupusa.com)



#111e

111f. Continuous Hinges – gear type with hospital tip  
**SL11 Concealed single acting continuous geared hinge**

Select Products Limited

Portage MI 49024

800-423-1174

[www.selecthinges.com](http://www.selecthinges.com)



#111f

111g. Continuous hinges  
**Anti-Ligature Continuous Swing Hinge for Shower w/ Cap# KG203**

Kingsway Group USA

Royal Oak, MI 48073

800-783-7980

[www.kingswaygroupusa.com](http://www.kingswaygroupusa.com)

113a. Double-acting continuous hinge  
**Double Swing Hinge #DSH1000 Barrel Type**

Markar

Memphis, TN 38181

[www.assaabloydooraccessories.us/en/local/assaabloydooraccessoriesus/products/hinges/continuous-pin-barrel-hinges/behavioral-health-hinges/](http://www.assaabloydooraccessories.us/en/local/assaabloydooraccessoriesus/products/hinges/continuous-pin-barrel-hinges/behavioral-health-hinges/)



#113a

*Inclusion or exclusion of a product does not indicate endorsement or disapproval of that product, nor does it suggest that any product is free of risk. All products must be in compliance with the organization's Environmental Safety Risk Assessment for each location.*

113c. Double-acting continuous hinge

**Swing Hinge # KG202**

Kingsway Group USA  
 Royal Oak, MI 48073  
 800-783-7980  
[www.kingswaygroupusa.com](http://www.kingswaygroupusa.com)



113d. Double-acting continuous hinge

**Switch Hinge # KG280**

Kingsway Group USA  
 Royal Oak, MI 48073  
 800-783-7980  
[www.kingswaygroupusa.com](http://www.kingswaygroupusa.com)



**#113d**

115b. Emergency stop

**Emergency Release Stop #ERS**

Pemko Manufacturing Company  
 Memphis, TN 38141  
 800-824-3018  
[www.pemko.com](http://www.pemko.com)



**Open**  
**#115b**



**Normal**  
**#115b**

115c. Emergency stop

**Swing Stop # KG205, KG206**

Kingsway Group USA  
 Royal Oak, MI 48073  
 800-783-7980  
[www.kingswaygroupusa.com](http://www.kingswaygroupusa.com)

120. Door pull

**Vandal-Resistant Door Pull Trim # VR910-DT**

Ives  
 Indianapolis, IN 46219  
 877-671-7011  
[us.allegion.com](http://us.allegion.com)



**#120**

121c. Door pull, recessed

**Heavy Duty Security Flush Pull # D89**

Rockwood Manufacturing Company  
Rockwood, PA 15557  
800-458-2424  
[www.rockwoodmfg.com](http://www.rockwoodmfg.com)



#121c

121d. Door pull, recessed

**Heavy Duty ADA Security Flush Pull # BF97L**

Rockwood Manufacturing Company  
Rockwood, PA 15557  
800-458-2424  
[www.rockwoodmfg.com](http://www.rockwoodmfg.com)



#121d

130a. Ligature-resistant lever handle lockset

**Anti Ligature Lockset (Mortise and Cylindrical) #SPSL**

Best Access Systems  
Indianapolis, IN 46250  
317-849-2250  
[www.bestaccess.com/index.php/products/behavioral-health-products/](http://www.bestaccess.com/index.php/products/behavioral-health-products/)



#130a

130b. Ligature-resistant lever handle lockset

**Schlage L Series Extra Heavy Duty Mortise Lock with ligature resistant lever**

Allegion  
877-671-7011  
[us.allegion.com/IRSTDocs/Brochure/106510.pdf](http://us.allegion.com/IRSTDocs/Brochure/106510.pdf)



#130b

130c. Ligature-resistant lever handle lockset

**Series 5SS19 Institutional Life Safety Mortise Locksets - Levers**

Marks USA  
Amityville, NY 11701  
800-526-0233  
[www.marksusa.com](http://www.marksusa.com)



#130c

*Inclusion or exclusion of a product does not indicate endorsement or disapproval of that product, nor does it suggest that any product is free of risk. All products must be in compliance with the organization's Environmental Safety Risk Assessment for each location.*



130d. Ligature-resistant lever handle lockset

**LSL Life Safety Lever Series**

Grainger

Lake Forest, IL 60045

800-472-4643

[www.grainger.com](http://www.grainger.com)



#130d

131a. Ligature-resistant modified lever handle lockset

**8200 with BHW Trim**

Sargent Manufacturing Company

100 Sargent Drive

New Haven, CT 06536-0915

800-727-5477

[www.sargentlock.com](http://www.sargentlock.com)



#131a

131b. Ligature-resistant modified lever handle lockset

**Crescent Handle – horizontal installation**

Accurate Lock and Hardware

Stamford, CT 06902

203-348-8865

[www accuratelockandhardware.com](http://www accuratelockandhardware.com)



#131b

131c. Ligature-resistant modified lever handle lockset

**Securitech; Solis handle available for both mortise and cylindrical locksets)**

Securitech Group, Inc.

Maspeth, NY 11378

800-622-5625

[www.securitech.com/securiguard/](http://www.securitech.com/securiguard/)



#131c

131d. Ligature-resistant modified lever handle lockset

**HD Ligature Resistant Cylindrical Lock CH-CYL Series**

Accurate Lock and Hardware

Stamford, CT 06902

203-348-8865

[www accuratelockandhardware.com](http://www accuratelockandhardware.com)



#131d

*Inclusion or exclusion of a product does not indicate endorsement or disapproval of that product, nor does it suggest that any product is free of risk. All products must be in compliance with the organization's Environmental Safety Risk Assessment for each location.*

## 132a. Ligature-resistant lockset

**Ligature Resistant Push/Pull 9125ALP**

Accurate Lock and Hardware

Stamford, CT 06902

203-348-8865

[www accuratelockandhardware.com](http://www accuratelockandhardware.com)

#132a

## 140. Patient room privacy lockset

**Patient Room Privacy Lockset**

Best Access Systems

Indianapolis, IN 46250

800-392-5209

[www.bestaccess.com/products/behavioral-health-products/](http://www.bestaccess.com/products/behavioral-health-products/)

#140

## 141a. Cylinder protector

**Securiguard Cylinder Protector; Model #63LR**

Securitech Group, Inc.

Maspeth, NY 11378

800-622-5625

[www.securitech.com/securiguard/](http://www.securitech.com/securiguard/)

#141a

## 141b. Cylinder protector

**ShieldX Cylinder Protector**

Grainger

Lake Forest, IL 60045

800-472-4643

[www.grainger.com](http://www.grainger.com)

#141b

*Inclusion or exclusion of a product does not indicate endorsement or disapproval of that product, nor does it suggest that any product is free of risk. All products must be in compliance with the organization's Environmental Safety Risk Assessment for each location.*

## 143a. Deadbolt

**Deadbolt with ligature-resistant turn piece (retract bolt only) #PBL102-630**

Securitech Group, Inc.  
Maspeth, NY 11378  
800-622-5625  
[www.securitech.com](http://www.securitech.com)



## 143b. Deadbolt

**Vertical Deadbolt with ligature-resist. turn piece (retract bolt only) #52XXV-F17**

Securitech Group, Inc.  
Maspeth, NY 11378  
800-622-5625  
[www.securitech.com](http://www.securitech.com)

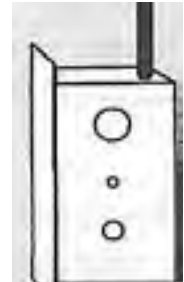

## 144. Sallyport interlock hardware

**RACHIE™ series lockset package**

Securitech Group, Inc.  
Maspeth, NY 11378  
800-622-5625  
[www.securitech.com](http://www.securitech.com)



## 145. Remote authorization

**Assa Cliq Remote Authorization System**

Assa Abloy  
[www.assaboly.com](http://www.assaboly.com)



## 146. Ball catch

**Dual Adjustable Ball Catch #347**

Ives  
 Indianapolis, IN 46219  
 877-671-7011  
[us.allegion.com](http://us.allegion.com)



## 147. Roller latch

**Roller Latch # RL30**

Ives  
 Indianapolis, IN 46219  
 877-671-7011  
[us.allegion.com](http://us.allegion.com)



## 148. Magnetic latch

**Super-Mite Heavy Duty Magnetic Catch #327**

Ives  
 Indianapolis, IN 46219  
 877-671-7011  
[us.allegion.com](http://us.allegion.com)



## 150a. Over-door alarm

**The Door Switch**

St. Louis, MO 63146  
 877-998-5625  
[thedoorswitch.com](http://thedoorswitch.com)



## 150b. Over-door alarm

**Top Door Alarm®**

Door Control Services, Inc.  
 Ben Wheeler, TX 75754  
 800-356-2025  
[www.doorcontrolservices.com](http://www.doorcontrolservices.com)



*Inclusion or exclusion of a product does not indicate endorsement or disapproval of that product, nor does it suggest that any product is free of risk. All products must be in compliance with the organization's Environmental Safety Risk Assessment for each location.*

## 150c. Over-door alarm

**SEDA Door Alarm**

Best Access Solutions, Inc.  
Indianapolis, IN 46250

[www.bestaccess.com/products/behavioral-health-products/](http://www.bestaccess.com/products/behavioral-health-products/)



## 150d. Over-door alarm

**LISA-Kit (Life Safety Alarm)**

Grainger  
Lake Forest, IL 60045  
800-472-4643

[www.grainger.com](http://www.grainger.com)



## 150d. Over-door alarm

**DAISY – Over-the-Door Alarm)**

Securitech Group, Inc.  
Maspeth, NY 11378  
800-622-5625

[www.securitech.com](http://www.securitech.com)



## 160a. Seclusion room door locks

**Seclusion Room Lock (surface mount)**

Securitech  
Maspeth, NY 11378  
800-622-5625

[www.securitech.com](http://www.securitech.com)



## 160b. Seclusion room door locks

**Multi-Point Deadbolt Mortise Lock - UML Series (concealed mount)**

Securitech  
Maspeth, NY 11378  
800-622-5625

[www.securitech.com](http://www.securitech.com)



*Inclusion or exclusion of a product does not indicate endorsement or disapproval of that product, nor does it suggest that any product is free of risk. All products must be in compliance with the organization's Environmental Safety Risk Assessment for each location.*



160c. Seclusion room door locks

**Schlage; Multipoint Solution # LM9300**

Ingersoll Rand Security Technologies  
 Carmel, IN 46032 US  
 877-671-7011

[us.allegion.com/IRSTDocuments1/104833.pdf](http://us.allegion.com/IRSTDocuments1/104833.pdf)



#160c

160d. Seclusion room door locks

**Multi-Bolt Self-Latching Concealed Locksets (USL Series)**

Securitech  
 Maspeth, NY 11378  
 800-622-5625

[www.securitech.com](http://www.securitech.com)



#160d

161. Cross-corridor door locks

**Electra Concealed Vertical Rod Latching Lever Locksets #109**

Securitech  
 Maspeth, NY 11378  
 800-622-5625

[www.securitech.com](http://www.securitech.com)



#161

162. Elopement buffer or sallyport door locks

**RACHIE Entry & Exit Control Systems**

Securitech  
 Maspeth, NY 11378  
 800-622-5625

[www.securitech.com](http://www.securitech.com)



#162

175a. Wall Stops

**KG184 Anti-Ligature Rubber Wall Stop**

Kingsway Group USA  
 Royal Oak, MI 48073  
 800-783-7980

[www.kingswaygroupusa.com](http://www.kingswaygroupusa.com)



#175a

*Inclusion or exclusion of a product does not indicate endorsement or disapproval of that product, nor does it suggest that any product is free of risk. All products must be in compliance with the organization's Environmental Safety Risk Assessment for each location.*

## 175b. Wall Stops

**KG270-278 Anti-Ligature Extended Rubber Wall Stop**

Kingsway Group USA

Royal Oak, MI 48073

800-783-7980

[www.kingswaygroupusa.com](http://www.kingswaygroupusa.com)

#175b

**08 87 53 – Security Films**

## 190a. Window film

**Scotchshield™ – 14 mil Film with Perimeter Attachment System**

3M Specified Construction Products Department

St. Paul, MN 55144

888-364-3577

[www.3m.com](http://www.3m.com)

## 190b. Window film

**200 Series – Safety and Security Laminate**

ACE (Advanced Coatings Engineering)

Newark, DE 19713

888-607-0000

[www.usace.com](http://www.usace.com)**08 88 53 – Security Glazing**

## 200a. Security glazing

**121000 or 121100 ArmorProtect Plus®**

Oldcastle Building Envelope®

Dallas, TX 75244

866-653-2278

[www.obe.com](http://www.obe.com)

## 200b. Security glazing

**9/16Psych-2118**

Global Security Glazing

Selma, AL 36703

(800) 633-2513

[www.security-glazing.com](http://www.security-glazing.com)**(NOTE: meets ASTM F1233 Class 1.4)**

#200b

*Inclusion or exclusion of a product does not indicate endorsement or disapproval of that product, nor does it suggest that any product is free of risk. All products must be in compliance with the organization's Environmental Safety Risk Assessment for each location.*

## 200c. Security glazing

**Laminated Annealed Glass w/ SGP Interlayer**

Global Security Glazing

Selma, AL 36703

(800) 633-2513

[www.security-glazing.com](http://www.security-glazing.com)

## 201a. Polycarbonate sheet glazing – abrasion-resistant

**MR10 LEXAN - MARGARD II Sheet**

SABIC Americas

Pittsfield, MA 01201

800-323-3783

[www.sabic.com](http://www.sabic.com)

## 201b. Polycarbonate sheet glazing

**Makrolon® GP Sheet**

Covestro LLC

Pittsburgh, PA 15205-9723

877-229-3778

[www.sheets.covestro.com](http://www.sheets.covestro.com)

## 205a. Fire-rated glazing

**Fireglass; FireLite®**

Technical Glass Products (TGP) (Allegion)

800-426-0279

[www.fireglass.com](http://www.fireglass.com)

## 205b. Fire-rated glazing

**Fireglass; WireLite® - NT**

Technical Glass Products (TGP) (Allegion)

800-426-0279

[www.fireglass.com](http://www.fireglass.com)

*Inclusion or exclusion of a product does not indicate endorsement or disapproval of that product, nor does it suggest that any product is free of risk. All products must be in compliance with the organization's Environmental Safety Risk Assessment for each location.*

## 220a. Vision panels

**Vision panels, key operation**

VISTAMATIC®

Coral Springs, FL 33065

866-466-9525

[www.vistamaticvisionpanels.com](http://www.vistamaticvisionpanels.com)

## 220b. Vision panels

**Duralux Secure Privacy Vision Panel**

Kingsway Group USA

Royal Oak, MI 48073

800-783-7980

[www.kingswaygroupusa.com](http://www.kingswaygroupusa.com)

## 220c. Vision panels

**Fixed or motorized blinds inside glass panels**

Unicel Architectural Corp.

Longueuil, Quebec, Canada J4G 2J4

800-668-1580

[www.unicelarchitectural.com](http://www.unicelarchitectural.com)

#220b

## 200d. Vision panels

**ViuLite manual or motorized blinds inside glass panels**

Unicel Architectural Corp.

Longueuil, Quebec, Canada J4G 2J4

800-668-1580

[www.unicelarchitectural.com](http://www.unicelarchitectural.com)

#220c

## 220e. Vision panels

**Between Glass Blinds vision panels**

VISTAMATIC, LLC

Coral Springs, FL 33065

866-466-9525

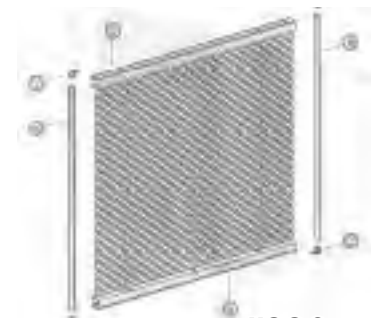
[www.betweenglassblinds.com](http://www.betweenglassblinds.com)

#220e

*Inclusion or exclusion of a product does not indicate endorsement or disapproval of that product, nor does it suggest that any product is free of risk. All products must be in compliance with the organization's Environmental Safety Risk Assessment for each location.*

## 220e. Vision panels

**IE; Blinds® sealed, integral blind assemblies**

IE Blinds

Ben Wheeler, TX 75754

866-267-1917

[www.ieblinds.com](http://www.ieblinds.com)

#220e

## 221a. Vision panels

**Clarity Privacy Glass (electric)**

VISTAMATIC®

Coral Springs, FL 33065

866-466-9525

[www.vistamaticvisionpanels.com](http://www.vistamaticvisionpanels.com)

#221a

## 221b. Vision Panels

**Duralux Platinum Switchable Vision Panel (electric)**

Kingsway Group USA

Royal Oak, MI 48073

800-783-7980

[www.kingswaygroupusa.com](http://www.kingswaygroupusa.com)

#221b

## 09 00 00 – Finishes

### 09 21 16 – Gypsum Board

## 230a. Impact-resistant gypsum board

**Sheetrock® Brand engineered gypsum panels – abuse-resistant**

USG Corporation

Chicago, IL 60661

800-874-4968

[www.usg.com](http://www.usg.com)

## 230b. Impact-resistant wallboard

**Gold Bond® Brand Hi-Impact® XP® Gypsum Board – moisture- and fire-resistant also has abrasion resistant paper face**

National Gypsum Company

Charlotte, NC 28211

704-365-7300

[www.nationalgypsum.com](http://www.nationalgypsum.com)

*Inclusion or exclusion of a product does not indicate endorsement or disapproval of that product, nor does it suggest that any product is free of risk. All products must be in compliance with the organization's Environmental Safety Risk Assessment for each location.*



230c. Impact-resistant wallboard

**Extreme Impact Resistant Type X Gypsum Board**

CertainTeed Corporation

Melvern, PA 19355

800-233-8990

[www.certainteed.com](http://www.certainteed.com)

231a. Abrasion-resistant wallboard

**Gold Bond® Brand Hi-Abuse® XP® Gypsum Board**

National Gypsum Company

Charlotte, NC 28211

704-365-7300

[www.nationalgypsum.com](http://www.nationalgypsum.com)

231b. Abrasion-resistant wallboard

**Extreme Abuse Resistant Type X Gypsum Board**

CertainTeed Corporation

Melvern, PA 19355

800-233-8990

[www.certainteed.com](http://www.certainteed.com)

232a. Sound-absorbing wallboard

**QuietRock sound-reducing panels**

PABCO® Gypsum

Newark, CA 94560

800-797-8159

[www.quietrock.com](http://www.quietrock.com)

232b. Sound-absorbing wallboard

**Silent FX Quick Cut Noise Reducing Type X Gypsum Board**

CertainTeed Corporation

Melvern, PA 19355

800-233-8990

[www.certainteed.com](http://www.certainteed.com)

*Inclusion or exclusion of a product does not indicate endorsement or disapproval of that product, nor does it suggest that any product is free of risk. All products must be in compliance with the organization's Environmental Safety Risk Assessment for each location.*

232c. Sound Attenuation wallboard

**Gold Bond® Soundboard® XP® Gypsum Board**

National Gypsum Company

Charlotte, NC 28211

704-365-7300

[www.nationalgypsum.com](http://www.nationalgypsum.com)

## 09 50 00 – Ceilings

234a. Ceiling Accessories

**MBAC – Main Beam Adapter Clip for attaching gyp. bd. to ceiling grid**

Armstrong Ceiling Solutions

[www.armstrongceilings.com](http://www.armstrongceilings.com)



#234a

239a. Tamper-resistant ceiling panels

**Metal Works; Vector**

Armstrong Ceiling Solutions

877-276-7876

[www.armstrongceilings.com](http://www.armstrongceilings.com)

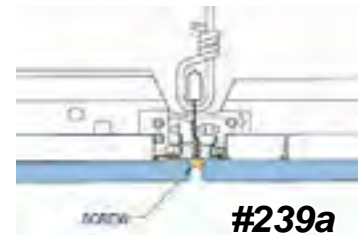

#239a

239b. Tamper-resistant ceiling panels

**Metal Works; Clip-On**

Armstrong Ceiling Solutions

877-276-7876

[www.armstrongceilings.com](http://www.armstrongceilings.com)

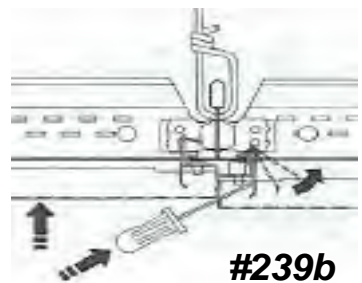

#239b

## 09 65 13 – Resilient Base

240. Wall base

**Health Design™ Wall Base**

FLEXCO® Corporation

Tuscumbia, AL 35674

800-633-3151

[www.flexcofloors.com](http://www.flexcofloors.com)



*Inclusion or exclusion of a product does not indicate endorsement or disapproval of that product, nor does it suggest that any product is free of risk. All products must be in compliance with the organization's Environmental Safety Risk Assessment for each location.*

241a. Wall base

**Visuelle Wall Base**

Roppe Corporation, USA  
Fostoria, OH 44830  
800-537-9527  
[www.roppe.com](http://www.roppe.com)



241b. Wall base

**Johnsonite “Millwork” Contours Wall Base – PV4065**

Tarkett  
30000 Aurora Road  
Solon, OH 44139  
800-899-8916  
[www.tarkettna.com](http://www.tarkettna.com)



## 09 65 16 – Resilient Flooring

245a. Sheet vinyl flooring

**Homogeneous Vinyl Sheet Flooring**

Armstrong Flooring, Inc.  
Lancaster, PA 17604  
888-276-7876  
[www.armstrong.com](http://www.armstrong.com)



245b. Sheet vinyl flooring

**Noraplan sheet flooring**

nora® systems, Inc.  
Salem, NH 03079  
800-332-NORA  
[www.nora.com/us](http://www.nora.com/us)

## 09 67 00 – Fluid-Applied Flooring

250a. Seamless floors and base

**Cheminert K flooring**

Dex-O-Tex  
Division of Crossfield Products Corp.  
Roselle Park, NJ 07204  
908-245-2800  
[www.dexotex.com](http://www.dexotex.com)

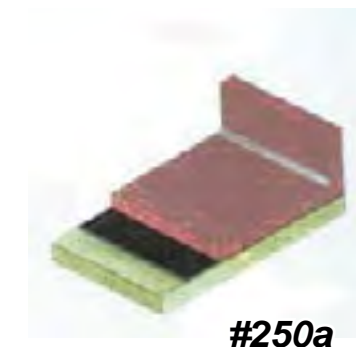

250b. Seamless floors and base

*Inclusion or exclusion of a product does not indicate endorsement or disapproval of that product, nor does it suggest that any product is free of risk. All products must be in compliance with the organization's Environmental Safety Risk Assessment for each location.*

**Seamless flooring systems**

Dur-A-Flex, Inc.  
 East Hartford, CT 06108  
 877-2 51-5418  
[www.dur-a-flex.com](http://www.dur-a-flex.com)

250c. Seamless floors and base

**Sika Corp.; Sikafloor – no top edge trim at integral base**

Sika Corporation  
 Lyndhurst, NJ 07071  
 800-933-7452  
[www.sikafloorusa.com](http://www.sikafloorusa.com)

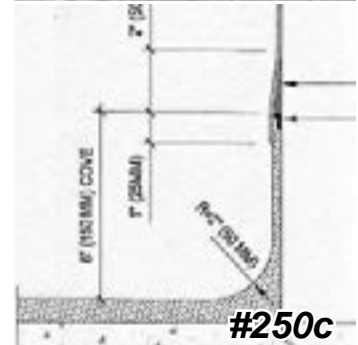

**09 68 16 – Sheet Carpeting**

255. Carpet

**Mohawk Group GL 182 Exotic Fauna Sheet Carpet with Unibond Plus Bloc backing**

Mohawk Group  
 Calhoun, GA 30701  
 800-554-6637  
[www.Mohawkgroup.com](http://www.Mohawkgroup.com)

**09 77 00 – Special Wall Surfacing**

270a. Wall padding

**Gold Medal Safety Padding®**

Marathon Engineering Corporation  
 Lehigh Acres, FL 33913  
 239-303-7378  
[goldmedalsafetypadding.com](http://goldmedalsafetypadding.com)

270b. Wall padding

**Surface padding systems**

Padded Surfaces by B&E  
 Indianapolis, IN 46241  
 888-243-8788  
[paddedsurfaces.com](http://paddedsurfaces.com)



*Inclusion or exclusion of a product does not indicate endorsement or disapproval of that product, nor does it suggest that any product is free of risk. All products must be in compliance with the organization's Environmental Safety Risk Assessment for each location.*

## 272. Seclusion room wall and floor material

**Lonfloor Plain – smooth**

Lonseal, Inc.  
 Carson, CA 90745  
 800-832-7111  
[www.lonseal.com](http://www.lonseal.com)

## 09 96 13 – Abrasion Resistant Coatings

## 280. Wall finish (do not use on floors)

**Sto; Decocoat®**

Sto Americas  
 Building 1400, Suite 120  
 Atlanta, GA 30331  
 800-221-2397  
[www.stocorp.com](http://www.stocorp.com)

## 10 00 00 – SPECIALTIES

### 10 12 00 – Display Cases

## 290a. TV enclosure – suicide-resistant

**TE450 Ligature-Resistant Protective TV Enclosure**

Behavioral Safety Products  
 Watkinsville, GA 30677  
 706-705-1500  
[www.besafepro.com](http://www.besafepro.com)



#290a

## 290b. TV Enclosure – suicide resistant

**Protective Enclosures, FPE55F(H)-S**

Peerless A-V  
 Aurora, IL 60502  
 800-865-2112  
[www.perlessmounts.com](http://www.perlessmounts.com)



#290b

*Inclusion or exclusion of a product does not indicate endorsement or disapproval of that product, nor does it suggest that any product is free of risk. All products must be in compliance with the organization's Environmental Safety Risk Assessment for each location.*



290c. TV enclosure – suicide-resistant

**Ligature-resistant TV enclosure**

ProEnc

Jersey City, NJ 07302

862-234-5981

[www.lcdtvenclosure.com](http://www.lcdtvenclosure.com)



#290c

## 10 14 00 – Signage

300a. Room signs

**Flxsigns**

2/90 Sign Systems

Grand Rapids, MI 49512

800-777-4310

[www.290signs.com](http://www.290signs.com)



#300a

300b. Room signs

**Secure + spec**

Creative Signage Systems, Inc.

College Park, MD 20740

800-220-7446

[www.creativesignage.com](http://www.creativesignage.com)



#300b

300c. Room signs

**KING KMS® Modular Sign System**

King Architectural Products

Bolton, ON, Canada, L7E 2R6

877-857-2804

[www.kingarchitecturalproducts.com](http://www.kingarchitecturalproducts.com)



#300c

300d. Room signs

**Safecare Signs**

2/90 Sign Systems

Grand Rapids, MI 49512

800-777-4310

[www.290signs.com](http://www.290signs.com)



#300d

*Inclusion or exclusion of a product does not indicate endorsement or disapproval of that product, nor does it suggest that any product is free of risk. All products must be in compliance with the organization's Environmental Safety Risk Assessment for each location.*

## 10 26 16.16 – Protective Corridor Handrails

310a. Corridor handrail

**Acrovyn® ligature-resistant handrail with continuous aluminum mounting bracket**

Construction Specialties

Muncy, PA 17756

800-233-8493

[www.c-sgroup.com](http://www.c-sgroup.com)



#310a

## 10 26 23 – Protective Wall Covering

320a. Synthetic wall protection

**Avonite® Acrylic products - Wall Protection**

Avonite

Belen, NM 87002

800-4-AVONITE

[www.avonitesurfaces.com](http://www.avonitesurfaces.com)

320b. Synthetic wall protection

**Acrovyn by Design® Wall Protection**

Construction Specialties

Muncy, PA 17756

800-233-8493

[www.c-sgroup.com](http://www.c-sgroup.com)



#320

320c. Synthetic wall protection

**Ricochet Flexible Wall Protection**

Inpro Corporation

Muskego, WI 53150

800-222-5556

[inprocorp.com](http://inprocorp.com)



#320c

*Inclusion or exclusion of a product does not indicate endorsement or disapproval of that product, nor does it suggest that any product is free of risk. All products must be in compliance with the organization's Environmental Safety Risk Assessment for each location.*

## 10 28 13 – Security Toilet Accessories

332a. Grab bar

**Anti-Ligature Grab Bar KG270-278**

Kingsway Group USA

Royal Oak, MI 48073

800-783-7980

[www.kingswaygroupusa.com](http://www.kingswaygroupusa.com)

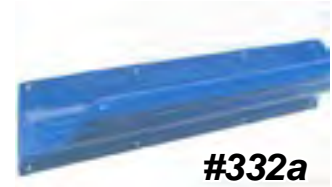

332b. Grab bar

**Ligature - Resistant Grab Bar #GB730**

Behavioral Safety Products

Watkinsville, GA 30677

706-705-1500

[www.besafepro.com](http://www.besafepro.com)



332c. Grab bar

**SAFEBAR® grab bar**

Cascade Specialty Hardware, Inc.

Vancouver, WA 98660

360-823-3995

[www.cascadesh.com](http://www.cascadesh.com)

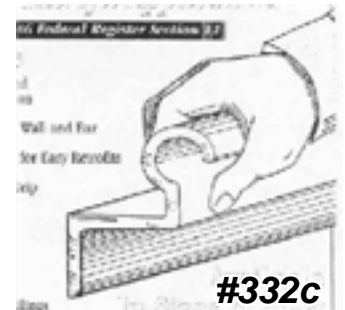

332d. Grab bar

**SafeSupport® Safe-T Grab Bar #811-S01**

Weizel Security

800-308-3627

[www.securingshospitals.com](http://www.securingshospitals.com)



332e. Grab bar

**NW SecurityBar®**

Northwest Specialty Hardware, Inc.

Clackamas, OR 97015

503-557-1881

[www.northwestsh.com](http://www.northwestsh.com)



*Inclusion or exclusion of a product does not indicate endorsement or disapproval of that product, nor does it suggest that any product is free of risk. All products must be in compliance with the organization's Environmental Safety Risk Assessment for each location.*

337. Grab bar – vertical

**SP-3V Vertical Grab Bar**

Odd Ball Industries  
 Greenlawn, NY 11740  
 631-754-0400  
[www.oddballindustries.com](http://www.oddballindustries.com)



**Cross  
 Section  
 #337**

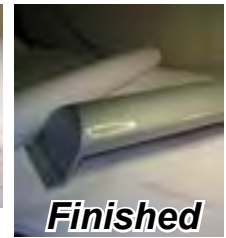

**Finished  
 End  
 #337**

340. Paper towel dispenser

**Paper Towel Dispenser Cover #817-S45 SR™**

Weizel Security  
 800-308-3627  
[www.securingshospitals.com](http://www.securingshospitals.com)



**#340**

340b. Paper towel dispenser

**Paper Towel Dispenser # KG02**

Kingsway Group USA  
 Royal Oak, MI 48073  
 800-783-7980  
[www.kingswaygroupusa.com](http://www.kingswaygroupusa.com)



**#340b**

340c. Paper Towel Dispenser

**Ligature - Resistant Paper Towel Dispenser #PH240**

Behavioral Safety Products  
 Watkinsville, GA 30677  
 706-705-1500  
[www.besafepro.com](http://www.besafepro.com)



**#340c**

341. Roll Paper Towel Dispenser

**Roll Paper Towel Dispenser #WH1848B**

Whitehall Manufacturing  
 City of Industry, CA 91744  
 1-800-782-7706  
[www.whitehallmfg.com](http://www.whitehallmfg.com)



**#341**

*Inclusion or exclusion of a product does not indicate endorsement or disapproval of that product, nor does it suggest that any product is free of risk. All products must be in compliance with the organization's Environmental Safety Risk Assessment for each location.*

350a. Robe hook – break-away

**Towel Hook #TH770**

Behavioral Safety Products  
Watkinsville, GA 30677  
706-705-1500  
[www.besafepro.com](http://www.besafepro.com)

#350a



350b. Robe hook – break-away

**SafeSupport SR Collapsible Towel Hook # SR813-S08**

Weizel Security  
800-308-3627  
[www.securingshospitals.com](http://www.securingshospitals.com)

#350b



350d. Robe hook – break-away

**Clothes Hook #NW 608**

Northwest Specialty Hardware, Inc.  
Clackamas, OR 97015  
503-557-1881  
[www.northwestsh.com](http://www.northwestsh.com)

#350d



350e. Robe hook – breakaway

**Coat Hook # KG180**

Kingsway Group USA  
Royal Oak, MI 48073  
800-783-7980  
[www.kingswaygroupusa.com](http://www.kingswaygroupusa.com)

#350e



360a. Security Mirrors

**Hybrid Safety Mirror in Guardian Frame**

RAO Contract Sales, Inc.  
392 Atwood Place  
Wyckoff, NJ 07481  
800-445-7065  
[www.rao.com](http://www.rao.com)

#360a



360b. Security Mirrors

**ROVAL™ stainless steel mirror #20650-B**

American Specialties, Inc.  
Yonkers, NY 10701  
914-476-9000  
[www.americanspecialties.com](http://www.americanspecialties.com)

#360b



*Inclusion or exclusion of a product does not indicate endorsement or disapproval of that product, nor does it suggest that any product is free of risk. All products must be in compliance with the organization's Environmental Safety Risk Assessment for each location.*

## 360c. Security Mirrors

**Security mirror #JOC-161**

McGrory Glass, Inc.  
 Paulsboro, NJ 08066  
 856-579-3200  
[www.mcgrory-glass.com](http://www.mcgrory-glass.com)

## 360d. Security Mirrors

**Sole - Illuminated Mirror for High Abuse Applications**

Visa Lighting  
 Milwaukee, WI 53209  
 800-788-84272  
[www.visalighting.com](http://www.visalighting.com)



#360d

## 361a. Mirror guard

**Mirror Guard # SP-8**

Odd Ball Industries  
 Greenlawn, NY 11740  
 631-754-0400  
[www.oddballindustries.com](http://www.oddballindustries.com)



#361a

## 370a. Recessed shelf

**Ligature-Resistant Recessed Shelf (front mount through flange) # RS780**

Behavioral Safety Products  
 Watkinsville, GA 30677  
 706-705-1500  
[www.besafepro.com](http://www.besafepro.com)



## 370b. Recessed Shelf

**Ligature-Resistant Recessed Shelf (front mount through flange) #KG12**

Kingsway Group USA  
 2807 Samoset Road, Suite 200  
 Royal Oak, MI 48073  
 800-783-7980  
[www.kingswaygroupusa.com](http://www.kingswaygroupusa.com)



#370b

*Inclusion or exclusion of a product does not indicate endorsement or disapproval of that product, nor does it suggest that any product is free of risk. All products must be in compliance with the organization's Environmental Safety Risk Assessment for each location.*



## 370c. Recessed shelf

**BestCare® Recessed Shelf (front mount through flange) # WH1820FA**

Whitehall Manufacturing  
 City of Industry, CA 91744-0527  
 800-782-7706  
[www.whitehallmfg.com](http://www.whitehallmfg.com)



## 370d. Recessed shelf

**Recessed Shelf (front mount through side) # Model 412**

American Specialties, Inc.  
 Yonkers, NY 10701  
 914-476-9000  
[www.americanspecialties.com](http://www.americanspecialties.com)



## 371c. Shelf – surface-mounted

**Bookshelf # SA56**

Bradley Corporation  
 Menomonee Falls, WI 53051  
 800-272-3539  
[www.bradleycorp.com](http://www.bradleycorp.com)



## 380a. Shower seat

**ADA Shower Seat**

Norix Group, Inc.  
 West Chicago, IL 60185  
 800-234-4900  
[www.norix.com](http://www.norix.com)



## 380b. Shower seat

**ADA Shower Seat**

Brey-Krause Manufacturing Co.  
 Bethlehem, PA 18018  
 610-867-1401  
[www.breykrause.com](http://www.breykrause.com)



*Inclusion or exclusion of a product does not indicate endorsement or disapproval of that product, nor does it suggest that any product is free of risk. All products must be in compliance with the organization's Environmental Safety Risk Assessment for each location.*

## 390a. Soap Dish

**Bestcare Bathroom Accessory Solutions #WH1832-PF  
(front mount with plaster flange)**

Whitehall Manufacturing  
City of Industry, CA 91744  
1-800-782-7706  
[www.whitehallmfg.com](http://www.whitehallmfg.com)



## 390b. Soap dish

**Norix Group Inc.; Recessed Soap Dish (rear mount)**

Norix Group, Inc.  
West Chicago, IL 60185  
1-800-234-4900  
[www.norix.com](http://www.norix.com)

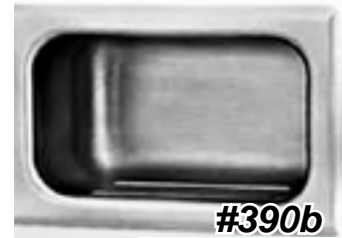

## 391a. Soap dispenser

**KG08 Manual Soap Dispenser – Gojo Compatible**

Kingsway Group USA  
Royal Oak, MI 48073  
800-783-7980  
[www.kingswaygroupusa.com](http://www.kingswaygroupusa.com)



## 391b. Soap dispenser

**ADX-12TM Security Enclosure**

GOJO Industries, Inc.  
Akron, OH 44309  
800-321-9647  
[www.gojo.com](http://www.gojo.com)



*Inclusion or exclusion of a product does not indicate endorsement or disapproval of that product, nor does it suggest that any product is free of risk. All products must be in compliance with the organization's Environmental Safety Risk Assessment for each location.*

391c. Soap dispenser

**Suicide Prevention Soap Dispenser**

Norva Plastics, Inc.

Norfolk, VA 23508

800-826-0758

[www.norvaplastics.com](http://www.norvaplastics.com)



391d. Soap dispenser

**Ligature Resistant Soap Dispenser #SD750**

Behavioral Safety Products

Watkinsville, GA 30677

706-705-1500

[www.besafepro.com](http://www.besafepro.com)



#391d

400a. Toilet paper holder

**Toilet Roll Holder # KG13**

Kingsway Group USA

Royal Oak, MI 48073

800-783-7980

[www.kingswaygroupusa.com](http://www.kingswaygroupusa.com)



#400a

400b. Toilet paper holder

**Toilet Roll Holder #WH1847B Series (Recessed model (1845B) also available)**

Whitehall Manufacturing

City of Industry, CA 91744

1-800-782-7706

[www.whitehallmfg.com](http://www.whitehallmfg.com)



#400b

*Inclusion or exclusion of a product does not indicate endorsement or disapproval of that product, nor does it suggest that any product is free of risk. All products must be in compliance with the organization's Environmental Safety Risk Assessment for each location.*

400c Toilet paper holder

**Surface Mount Toilet Roll Holder # KG03**

Kingsway Group USA

Royal Oak, MI 48073

800-783-7980

[www.kingswaygroupusa.com](http://www.kingswaygroupusa.com)



400d Toilet paper holder

**Ligature Resistant Toilet Paper Holder #TR740**

Behavioral Safety Products

Watkinsville, GA 30677

706-705-1500

[www.besafepro.com](http://www.besafepro.com)



400f. Toilet paper holder

**Safety Toilet Paper Holder #C-400**

Cascade Specialty Hardware, Inc.

Vancouver, WA 98660

360-823-3995

[www.cascadesh.com](http://www.cascadesh.com)



400h. Toilet paper holder

**Suicide-Resistant Toilet Paper Dispenser**

Norva Plastics, Inc.

Norfolk, VA 23508

800-826-0758

[www.norvaplastics.com](http://www.norvaplastics.com)



410a. Undersink protection

**Truebro® Lav Shield®**

IPS® Corporation

Compton, CA 90220

310-898-3300

[www.truebro.com](http://www.truebro.com)

410b. Undersink protection

**Undersink Enclosure #831-S27 SRTM**

Weizel Security

800-308-3627

[www.securingshospitals.com](http://www.securingshospitals.com)



*Inclusion or exclusion of a product does not indicate endorsement or disapproval of that product, nor does it suggest that any product is free of risk. All products must be in compliance with the organization's Environmental Safety Risk Assessment for each location.*

## 10 86 00 – Security Mirrors and Domes

420a. Convex mirrors

### ***DuraVision Quarter Dome Mirror***

Norix Group, Inc.  
West Chicago, IL 60185  
800-234-4900  
[www.norix.com](http://www.norix.com)



**#420a**

## 12 00 00 – FURNISHINGS

### 12 21 13 – Horizontal Louver Blinds

430a. Aluminum window with integral blind

### ***Storefront with hinged sash and integral blind #2450 Series***

Manko Window Systems, Inc.  
Manhattan, KS 66502  
800-642-1488  
[www.mankowindows.com](http://www.mankowindows.com)

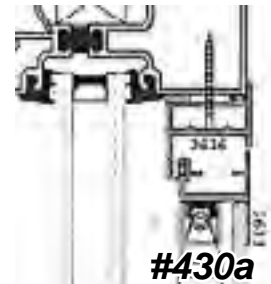

**#430a**

430b. Aluminum window with integral blind

### ***Psychiatric Windows with integral blind #2187-DT***

Wausau Window and Wall Systems  
Wausau, WI 54401  
877-678-2983  
[www.wausauwindow.com](http://www.wausauwindow.com)

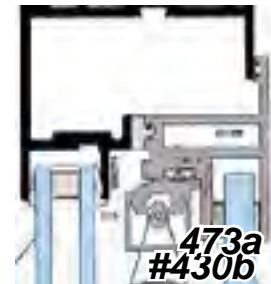

**473a  
#430b**

430c. Aluminum window with integral blind - removable

### ***Medium-Security Mental Health Security Window # SS-5100***

Sherwood Windows Group  
Toronto, Ontario M9W 5E3  
Canada  
800-770- 5256  
[www.sherwoodwindows.com](http://www.sherwoodwindows.com)



**#430c**

*Inclusion or exclusion of a product does not indicate endorsement or disapproval of that product, nor does it suggest that any product is free of risk. All products must be in compliance with the organization's Environmental Safety Risk Assessment for each location.*

## 434a. Exterior windows - ventilation

**Safevent Windows**

Britplas  
 Woolston, Warrington WA1 4RW  
 England  
 +44-1925-824317  
[www.britplas.com](http://www.britplas.com)



## 434b. Exterior windows - ventilation

**Operable Security Window # SW-6300**

Sherwood Windows Group  
 Toronto, Ontario M9W 5E3  
 Canada  
 800-770-5256  
[www.sherwoodwindows.com](http://www.sherwoodwindows.com)



## 434c. Exterior windows - ventilation

**512 Ventrow Ventilator**

Kawneer North America  
 Norcross, GA 30092  
 770-449-5555  
[www.kawneer.com](http://www.kawneer.com)

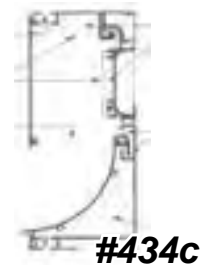

## 12 21 33 – Roll-Down Blinds

## 440a. Roller blinds

**Webb Lok cordless roller shades**

Inpro  
 Muskego, WI 53150  
 800-222-5556  
<https://www.inprocorp.com/clickeze-privacy-systems/specialty-window-shades>





## 12 35 70 – Healthcare Case Work

460a. Cabinet pulls

**Cabinet Pull # DP74C**

Doug Mockett & Company, Inc.

Torrance, CA 90501

800-523-1269

[www.mockett.com](http://www.mockett.com)

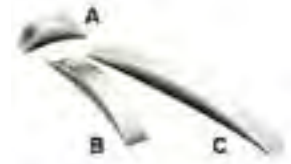

#460a

460b. Cabinet pulls

**Zinc Handle – polished chrome finish #104.66.200**

Hafele America Co.

Archdale, NC 27263

800-423-3531

[www.hafele.com/us/en](http://www.hafele.com/us/en)

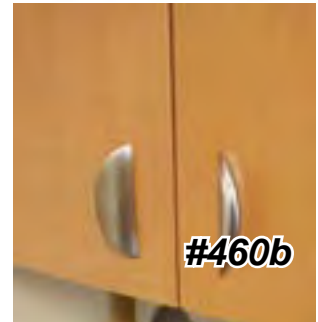

#460b

460c. Cabinet pulls

**Arc Cabinet Pull #DP18**

Doug Mockett & Company, Inc.

Torrance, CA 90501

800-523-1269

[www.mockett.com](http://www.mockett.com)



#460c

465a. Cabinet locks – keyless

**eLock®: Cabinet version #300 Series**

CompX Security Products

847-752-2500

[www.compxelock.com](http://www.compxelock.com)



#465a

465b. Cabinet locks – keyless

**dialock**

Hafele America Co.

800-423-3531

[www.hafele.com/us/en](http://www.hafele.com/us/en)



#465b

465c. Cabinet locks – keyless

**eLock: Cabinet Version #100 Series**

CompX Security Products

Mauldin, SC 29662

864-297-6655

[www.compxelock.com](http://www.compxelock.com)

*Inclusion or exclusion of a product does not indicate endorsement or disapproval of that product, nor does it suggest that any product is free of risk. All products must be in compliance with the organization's Environmental Safety Risk Assessment for each location.*

470a. Tamper-resistant screws  
**Socket Security & Torx Security**  
 Tamperproof Screw Company, Inc.  
 Hicksville, NY 11801  
 516-931-1616  
[www.tamperproof.com](http://www.tamperproof.com)



#470a

470b. Tamper-resistant screws  
**Security Pin Torx Screws and Bits**  
 Northwest Specialty Hardware, Inc.  
 Clackamas, OR 97015  
 503-557-1881  
[www.northwestsh.com](http://www.northwestsh.com)



#470b

**12 44 16 – Shower Doors**

473a. Shower doors  
**Wanford ShowerDoor**  
 Safehinge-Primera  
 UK  
 0330-058-0988  
[www.safehingeprimera.com](http://www.safehingeprimera.com)



#470a

473b. Shower doors  
**En-Suite Patient Bathroom Door w/ Shower Door**  
**Option: #SHDUS02**  
 Kingsway Group USA  
 Royal Oak, MI 48073  
 800-783-7980  
[www.kingswaygroupusa.com](http://www.kingswaygroupusa.com)



#473b

473c. Shower doors  
**Sentinel Event Reduction Shower Door**  
 Norva Plastics, Inc.  
 Norfolk, VA 23508  
 800-826-0758  
[www.norvaplastics.com](http://www.norvaplastics.com)



473c

*Inclusion or exclusion of a product does not indicate endorsement or disapproval of that product, nor does it suggest that any product is free of risk. All products must be in compliance with the organization's Environmental Safety Risk Assessment for each location.*

## 473d. Shower doors

**Soft Suicide Prevention Door**

Kennon Products, Inc.

Sheridan, WY 82801

307-674-6498

[www.suicideproofing.com](http://www.suicideproofing.com)

#473d

## 473e. Shower door hinge

**SwingHinge double action continuous hinge for SHOWER DOOR with surface cap and hinge cover plate # KG203**

Kingsway Group USA

Royal Oak, MI 48073

800-783-7980

[www.kingswaygroupusa.com](http://www.kingswaygroupusa.com)

#473e

## 473f. Shower door rubber fin

**Shower System Rubber Fin and mounting Section with top fixing bracket #SRF01**

Kingsway Group USA

Royal Oak, MI 48073

800-783-7980

[www.kingswaygroupusa.com](http://www.kingswaygroupusa.com)

#473f

Norix SafeDoor - [www.norix.com/product/safedoor](http://www.norix.com/product/safedoor)

*Inclusion or exclusion of a product does not indicate endorsement or disapproval of that product, nor does it suggest that any product is free of risk. All products must be in compliance with the organization's Environmental Safety Risk Assessment for each location.*

## 12 46 23 – Decorative Crafts

475. Vinyl artwork

**Soft Suicide Prevention Artwork (SSPA)**

Kennon Products, Inc.

Sheridan, WY 82801

307-674-6498

[www.suicideproofing.com](http://www.suicideproofing.com)

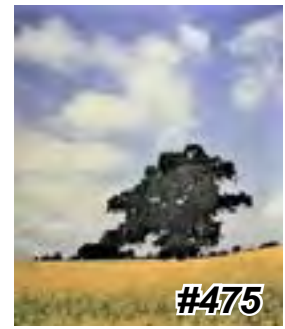

#475

476a. Ligature-resistant frames

**Solid surface frames**

Custom Design Frameworks

Mechanicsville, VA 23111

804-476-4233

[www.customdesignframeworks.com](http://www.customdesignframeworks.com)



#476a

476b. Ligature-resistant frames

**AF550 Ligature-Resistant Art Frame**

Behavioral Safety Products

Watkinsville, GA 30677

706-705-1500

[www.besafepro.com](http://www.besafepro.com)

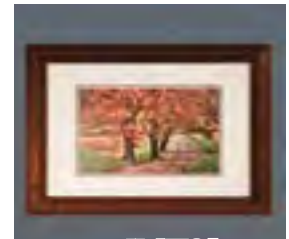

#476b

476c. Display boards

**Tak-Les Bulletin Board with Guardian Frame**

RAO Contract Sales, Inc.

Paterson, NJ 07501

800-445-7065

[www.rao.com](http://www.rao.com)



#476c

## 12 52 70 – Healthcare Seating

479a. Stools

**OFS Brands; Boost Ottoman**

OFS Brands

Huntingburg, IN 47542

800-521-5381

[info@ofsbrands.com](mailto:info@ofsbrands.com)



#479a

*Inclusion or exclusion of a product does not indicate endorsement or disapproval of that product, nor does it suggest that any product is free of risk. All products must be in compliance with the organization's Environmental Safety Risk Assessment for each location.*

## 479b. Stools

**Norix: Slammer Stool Series**

Norix Group, Inc.  
West Chicago, IL 60185  
800-234-4900  
[www.norix.com](http://www.norix.com)



## 480a. Sand-ballasted seating

**Ultra-Max Series**

Norix Group, Inc.  
West Chicago, IL 60185  
800-234-4900  
[www.norix.com](http://www.norix.com)



## 480b. Sand-ballasted seating

**Pineapple; Skye Plus ASKYP1-400**

Pineapple Contracts  
Clawson, MI 48017  
800-496-9324  
[www.pineapplecontracts.com](http://www.pineapplecontracts.com)



## 480c. Sand-ballasted seating

**Hardi Series Dining Chair #8701**

Spec Furniture Inc.  
Toronto, Ontario M9W 5B1  
Canada  
888-761-7732  
[www.specfurniture.com](http://www.specfurniture.com)



## 481a. Lightweight seating

**Integra Series chairs**

Norix Group, Inc.  
West Chicago, IL 60185  
800-234-4900  
[www.norix.com](http://www.norix.com)



*Inclusion or exclusion of a product does not indicate endorsement or disapproval of that product, nor does it suggest that any product is free of risk. All products must be in compliance with the organization's Environmental Safety Risk Assessment for each location.*

## 481b. Lightweight seating

**RazorBack Chair**

Cortech® USA  
Willowbrook, IL 60527  
800-571-0770  
[www.cortechusa.com](http://www.cortechusa.com)



#481b

## 481c. Lightweight seating

**Stackable chair #5000-20 Modumaxx**

Moduform  
Fitchburg, MA 01420  
800-221-6638  
[www.moduform.com](http://www.moduform.com)



#482e

## 481d. Lightweight seating

**Boden Series seating**

Pineapple Contracts, Inc.  
Clawson, MI 48017  
800-496-9324  
[www.pineapplecontracts.com](http://www.pineapplecontracts.com)



#481d

## 482a. Upholstered seating

**Sierra Series chairs with solid arms**

Norix Group, Inc.  
West Chicago, IL 60185  
800-234-4900  
[www.norix.com](http://www.norix.com)



#482a

## 482b. Upholstered seating

**Meridian Behavioral Health Seating – chair # ML30/27BH**

Nemschoff  
Sheboygan, WI 53081  
800-203-8916  
[www.nemschoff.com](http://www.nemschoff.com)



#482g

#482b

## 482c. Upholstered seating

**Wink Series Chair**

Norix Group, Inc.  
West Chicago, IL 60185  
800-234-4900  
[www.norix.com](http://www.norix.com)



#482c

*Inclusion or exclusion of a product does not indicate endorsement or disapproval of that product, nor does it suggest that any product is free of risk. All products must be in compliance with the organization's Environmental Safety Risk Assessment for each location.*



482d. Upholstered seating

**Endurance Series**

Blockhouse Company, Inc.  
 York, PA 17406  
 800-346-1126  
[www.blockhouse.com](http://www.blockhouse.com)



**#482d**

482e. Upholstered seating

**Dignity Series #4501M**

Spec Furniture Inc.  
 Toronto, Ontario M9W 5B1  
 Canada  
 888-761-7732  
[www.specfurniture.com](http://www.specfurniture.com)



482f. Upholstered seating

**Carrara**

Kwalu  
 Atlanta, GA 30328  
 877-695-9258  
[www.kwalu.com](http://www.kwalu.com)



**#482f**

482g. Upholstered seating

**Arcadia Series**

Blockhouse Company, Inc.  
 York, PA 17406  
 800-346-1126  
[www.blockhouse.com](http://www.blockhouse.com)



482h. Upholstered seating

**Sierra Series chairs with open arms**

Norix Group, Inc.  
 West Chicago, IL 60185  
 800-234-4900  
[www.norix.com](http://www.norix.com)



**#482h**

*Inclusion or exclusion of a product does not indicate endorsement or disapproval of that product, nor does it suggest that any product is free of risk. All products must be in compliance with the organization's Environmental Safety Risk Assessment for each location.*

482i. Upholstered seating

**Skye Plus ASKYP1-400**

Pineapple Contracts, Inc.  
Clawson, MI 48017  
800-496-9324

[www.pineapplecontracts.com](http://www.pineapplecontracts.com)



482j. Upholstered seating

**Domus Lounge Seating**

Pineapple Contracts, Inc.  
Clawson, MI 48017  
800-496-9324

[www.pineapplecontracts.com](http://www.pineapplecontracts.com)



482k. Upholstered seating

**Chaise Lounge Chair**

Blockhouse Company, Inc.  
York, PA 17406  
800-346-1126

[www.blockhouse.com](http://www.blockhouse.com)



483a. Rockers

**RockSmart**

Norix Group, Inc.  
West Chicago, IL 60185  
800-234-4900

[www.norix.com](http://www.norix.com)



483b. Rockers

**Hardi Rocking Chair**

Spec Furniture  
888-761-7732

[specfurniture.com](http://specfurniture.com)



*Inclusion or exclusion of a product does not indicate endorsement or disapproval of that product, nor does it suggest that any product is free of risk. All products must be in compliance with the organization's Environmental Safety Risk Assessment for each location.*

483c. Rockers

**Endurance Series Rocker**

Blockhouse Company, Inc.  
 York, PA 17406  
 800-346-1126  
[www.blockhouse.com](http://www.blockhouse.com)



#483c

484a. PVC molded seating

**Forté™ Lounge**

Norix Group, Inc.  
 West Chicago, IL 60185  
 800-234-4900  
[www.norix.com](http://www.norix.com)



#484a

484d. PVC molded seating

**Hondo® Nuevo**

Norix Group, Inc.  
 West Chicago, IL 60185  
 800-234-4900  
[www.norix.com](http://www.norix.com)



#484d

**12 56 70 – Healthcare Furniture**

485a. Tables

**Jupiter Series Tables**

Norix Group, Inc.  
 West Chicago, IL 60185  
 800-234-4900  
[www.norix.com](http://www.norix.com)



#485a

*Inclusion or exclusion of a product does not indicate endorsement or disapproval of that product, nor does it suggest that any product is free of risk. All products must be in compliance with the organization's Environmental Safety Risk Assessment for each location.*

## 485b. Tables

**Madera Series Tables**

Norix Group, Inc.  
West Chicago, IL 60185  
800-234-4900  
[www.norix.com](http://www.norix.com)



#485b

## 485c. Tables

**Tabla Series Drum Tables**

Norix Group, Inc.  
West Chicago, IL 60185  
800-234-4900  
[www.norix.com](http://www.norix.com)



#485c

## 490a. Electrically adjustable hospital bed

**Behavioral Health Bed™**

Sizewise  
Lenexa, KS 66215  
800-814-9389  
[www.sizewise.com](http://www.sizewise.com)



#490a

## 490b. Electrically adjustable hospital bed

**Spirit Bed with Mental Health Package**

CHG Hospital Beds  
London, ON N6E 1R6  
Canada  
866-516-5446  
[www.chgbeds.com](http://www.chgbeds.com)



#490b

## 490c. Electrically adjustable hospital bed

**MedSurg Bed #S3**

Stryker  
Kalamazoo, MI 49002  
269-385-2600  
[www.stryker.com](http://www.stryker.com)



#490c

*Inclusion or exclusion of a product does not indicate endorsement or disapproval of that product, nor does it suggest that any product is free of risk. All products must be in compliance with the organization's Environmental Safety Risk Assessment for each location.*

490d. Electrically adjustable hospital bed

**Mental Health Electric Bed**

Umano Medical, Inc.  
G0R 2Co, Canada  
1-844-409-4030

[www.umanomedical.com](http://www.umanomedical.com)



#490d

491a. Bedding

**One Piece Comfort and Safety Linen**

Harm Reduction Solutions  
San Diego, CA 92117  
858-500-2110

[www.harmreductionsolutions.com](http://www.harmreductionsolutions.com)



#491a

**492a. Behavioral health mattresses**

**Comfort Shield® Remedy Sealed Seam Mattress**

Norix Group, Inc.  
West Chicago, IL 60185  
800-234-4900

[www.norix.com](http://www.norix.com)

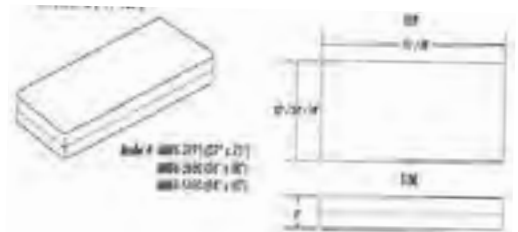

#492a

492b. Behavioral Health Mattresses

**Victory Series Mattresses**

Sizewise  
Lenexa, KS 66215 800-814-9389

[www.sizewise.net](http://www.sizewise.net)



492c. Behavioral health mattresses

**Behavioral Health Mattress with Bed Bug Protection**

**BioArmour™ Infection Control Composite Lamina Surface**

American Innovation Products  
Trinity, NC 27370  
814-490-0660

[www.americaninnovationproducts.com](http://www.americaninnovationproducts.com)

#492c

*Inclusion or exclusion of a product does not indicate endorsement or disapproval of that product, nor does it suggest that any product is free of risk. All products must be in compliance with the organization's Environmental Safety Risk Assessment for each location.*

492d. Behavioral health mattresses

**Closed System™ Behavioral Health Mattress**

Comfortex®  
 Winona, MN 55987  
 800-445-4007  
[www.comfortexinc.com](http://www.comfortexinc.com)



#492d

493a. Platform bed

**Attenda Series Roto Cast Bed**

Norix Group, Inc.  
 West Chicago, IL 60185  
 800-234-4900  
[www.norix.com](http://www.norix.com)



#493a

493d. Platform bed

**Behavioral Health Beds # BHBP/68 and BHHD/68**

Nemschoff  
 Sheboygan, WI 53081  
 800-203-8916  
[www.nemschoff.com](http://www.nemschoff.com)



#493d

493e. Platform bed

**Pineapple; Sovie Bed 1SVFA-100**

Pineapple Contracts, Inc.  
 Clawson, MI 48017  
 800-496-9324  
[www.pineapplecontracts.com](http://www.pineapplecontracts.com)



#493e

493g. Platform bed

**Behavioral Health Bed™ - Platform**

Sizewise  
 Lenexa, KS 66215  
 800-814-9389  
[www.sizewise.com](http://www.sizewise.com)



#493g

*Inclusion or exclusion of a product does not indicate endorsement or disapproval of that product, nor does it suggest that any product is free of risk. All products must be in compliance with the organization's Environmental Safety Risk Assessment for each location.*



## 493h. Platform bed

**Frontier bed**

Stance Healthcare  
 Kitchener, ON N2C 0B8  
 877-395-2623  
[www.stancehealthcare.com](http://www.stancehealthcare.com)



#493h

## 494a. Platform bed – lift-accessible

**Sleigh Bed**

Norix Group, Inc.  
 West Chicago, IL 60185  
 800-234-4900  
[www.norix.com](http://www.norix.com)



#494a

## 494b. Platform bed riser – lift-accessible

**Platform Bed Riser**

Norix Group, Inc.  
 West Chicago, IL 60185  
 800-234-4900  
[www.norix.com](http://www.norix.com)



#494b

## 495a. Patient room furniture

**VISTA Series**

Blockhouse Company, Inc.  
 York, PA 17406  
 800-346-1126  
[www.blockhouse.com](http://www.blockhouse.com)



#495a

## 495b. Patient room furniture

**Safehouse Series**

Norix Group, Inc.  
 West Chicago, IL 60185  
 800-234-4900  
[www.norix.com](http://www.norix.com)



#495b

*Inclusion or exclusion of a product does not indicate endorsement or disapproval of that product, nor does it suggest that any product is free of risk. All products must be in compliance with the organization's Environmental Safety Risk Assessment for each location.*

## 495c. Patient room furniture

**Safe & Tough series**

This End Up® Furniture Company, Inc.  
 Sanford, NC 27331  
 800-605-2130  
[www.thisendup.com/groupliving.com](http://www.thisendup.com/groupliving.com)



## 495d. Patient room furniture

**Endurance Series**

Cortech® USA  
 Willowbrook, IL 60527  
 800-571-0770  
[www.cortechusa.com](http://www.cortechusa.com)



## 495e. Patient room furniture

**Attenda Series**

Norix Group, Inc.  
 West Chicago, IL 60185  
 800-234-4900  
[www.norix.com](http://www.norix.com)



## 496a. Patient room cabinets

**Fortress Wardrobes**

Moduform  
 Fitchburg, MA 01420  
 800-221-6638  
[www.moduform.com](http://www.moduform.com)



## 496b. Patient Room cabinets

**Frontier bedside cabinet – flip style**

Stance Healthcare  
 Kitchener, ON N2C 0B8  
 877-395-2623  
[www.stancehealthcare.com](http://www.stancehealthcare.com)



*Inclusion or exclusion of a product does not indicate endorsement or disapproval of that product, nor does it suggest that any product is free of risk. All products must be in compliance with the organization's Environmental Safety Risk Assessment for each location.*

## 496c. Patient Room cabinets

**CPAP Cabinet**

Blockhouse Company, Inc.

York, PA 17406

800-346-1126

[www.blockhouse.com](http://www.blockhouse.com)

#496c

## 497a. Restraint bed

**450 Series Seclusion Beds (restraint loops optional)**

Moduform

Fitchburg, MA 01420

800-221-6638

[www.moduform.com](http://www.moduform.com)

#497a

## 497b. Restraint bed

**Duraguard bed with side bars**

Glasspec Corporation

Miami, FL 33256-0116

800-328-0888

[www.glasspec.com](http://www.glasspec.com)

#497b

## 498a. Removable Restraint Loops

**Attenda Restraint Rings (for use with Attenda beds)**

Norix Group, Inc.

West Chicago, IL 60185

800-234-4900

[www.norix.com](http://www.norix.com)

#498a

## 498b. Removable Restraint Loops

**Restraint Adapter and Buckle System**

SydLo Design LLC

South Range, Wisconsin

218-310-4351

[SydLoDesignLLC.com](http://SydLoDesignLLC.com)

#498b

*Inclusion or exclusion of a product does not indicate endorsement or disapproval of that product, nor does it suggest that any product is free of risk. All products must be in compliance with the organization's Environmental Safety Risk Assessment for each location.*

499a. Nurse servers

**WALLAroo®**

Carstens®, Inc.  
Chicago, IL 60706  
800-782-1524  
[www.carstens.com](http://www.carstens.com)



499b. Nurse servers

**Proximity EXT-28**

Proximity Systems  
800-437-8111  
[www.proximiiitysystems.com](http://www.proximiiitysystems.com)



**12 93 43 – Site Furnishings - Seating and Tables**

510. Outdoor Furniture

**Hilltop Outdoor Furniture**

Norix Group, Inc.  
West Chicago, IL 60185  
1-800-234-4900  
[www.norix.com](http://www.norix.com)



**21 00 00 - Fire Suppression**

**21 13 13 - Fire Suppression Sprinkler Systems**

520a. Fire sprinklers

**Raven 5.6K Institutional Sprinklers**

TYCO Fire Protection Products  
Lansdale, PA 19446  
800-523-6512  
[www.tyco-fire.com](http://www.tyco-fire.com)



520b. Fire sprinklers

**819-S17 SR Sprinkler**

Weizel Security  
800-308-3627  
[www.securinhospitals.com](http://www.securinhospitals.com)

#520a

*Inclusion or exclusion of a product does not indicate endorsement or disapproval of that product, nor does it suggest that any product is free of risk. All products must be in compliance with the organization's Environmental Safety Risk Assessment for each location.*

- 521a. Fire extinguisher cabinet  
**BestCare® Ligature-Resistant Recessed Fire Extinguisher Cabinet WH1704**  
 Whitehall Manufacturing  
 City of Industry, CA 91744-0527  
 800-782-7706  
[www.whitehallmfg.com](http://www.whitehallmfg.com)



#521a

## 22 43 00 – Plumbing Fixtures

### 22 43 13 – Healthcare Water Closets

531. Toilet fixture, ADA–floor-mounted, back outlet  
**Huron EverClean Flushometer Toilet with integral seat**  
 American Standard  
 Piscataway, NJ 08855  
 800-488-8049  
[www.americanstandard-us.com](http://www.americanstandard-us.com)



#531

533. Solid-surface toilet fixture  
**CWC-156 AST-FF Behavioral HealthCare Toilet**  
 Intersan Manufacturing Company  
 Phoenix, AZ 85007  
 602-254-3101  
[www.intersan.us](http://www.intersan.us)



#533

- 534a. Stainless steel toilet  
**ETW-1490 Series**  
 Willoughby Industries  
 Indianapolis, IN 46268  
 800-428-4065  
[www.willoughby-ind.com](http://www.willoughby-ind.com)



#534a

*Inclusion or exclusion of a product does not indicate endorsement or disapproval of that product, nor does it suggest that any product is free of risk. All products must be in compliance with the organization's Environmental Safety Risk Assessment for each location.*

534b. Toilet fixture – stainless steel

**BestCare® Ligature-Resistant Toilet, Wall Supply, WH2142-W**

Whitehall Manufacturing  
City of Industry, CA 91744  
800-782-7706  
[www.whitehallmfg.com](http://www.whitehallmfg.com)



#534b

536. Bariatric toilet fixtures

**BET-1490 Series – Bariatric toilets**

Willoughby Industries  
Indianapolis, IN 46268  
800-428-4065  
[www.willoughby-ind.com](http://www.willoughby-ind.com)



#536

## 22 43 16 – Healthcare Sinks

540a. Wall-Hung Corner Lavatories

**BestCare® Ligature-Resistant, ADA Compliant Corterra Cast Solid Surface Corner Basin; WH3776 Series**

Whitehall Manufacturing  
City of Industry, CA 91744-0527  
800-782-7706  
[www.whitehallmfg.com](http://www.whitehallmfg.com)



#540a

541a. Wall-Hung Lavatories

**HSL1 SafeCare Ligature-Resistant Lavatory – stainless steel or high-impact polymer trap cover**

Bradley Corporation  
Menomonee Falls, WI 53051  
800-272-3539  
[www.bradleycorp.com](http://www.bradleycorp.com)



#541a

542a. Vanity top lavatory

**Suicide Prevention Patient Sink Faucet**

Norva Plastics, Inc  
Norfolk, VA 23508  
800-826-0758  
[www.norvaplastics.com](http://www.norvaplastics.com)

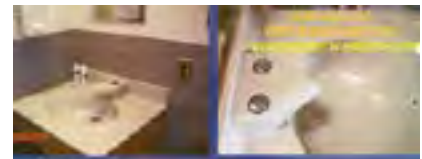

#542a

*Inclusion or exclusion of a product does not indicate endorsement or disapproval of that product, nor does it suggest that any product is free of risk. All products must be in compliance with the organization's Environmental Safety Risk Assessment for each location.*



542b. Vanity top lavatory  
**Avonite® Acrylic Solid Surfaces**  
 Avonite Surfaces  
 Florence, KY 41042  
 800-354-9858  
[www.avonite.com](http://www.avonite.com)

545. Hand Washing  
**Wallgate; Thrii (soap, water, drying)**  
 Intersan Manufacturing Company  
 Phoenix, AZ 85007  
 602-254-3101  
[www.intersan.us](http://www.intersan.us)



#545

**22 43 19 – Healthcare Bathtubs and Showers**

550a. Shower head – ligature resistant  
**SP-7 Shower Head**  
 Odd Ball Industries Mfg. Co., Inc.  
 Greenlawn, NY 11740  
 631-754-0400  
[www.oddballindustries.com](http://www.oddballindustries.com)



#545

550c. Shower head – ligature resistant  
**Ligature-Resistant Shower Head – SH330**  
 Behavioral Safety Products  
 Watkinsville, GA 30677  
 706-705-1500  
[www.besafepro.com](http://www.besafepro.com)



#550a

552a. Shower Control Valve



#550c

*Inclusion or exclusion of a product does not indicate endorsement or disapproval of that product, nor does it suggest that any product is free of risk. All products must be in compliance with the organization's Environmental Safety Risk Assessment for each location.*

**WH538-CSH Ligature-Resistant Shower Head and Valve**

Whitehall Manufacturing  
 City of Industry, CA 91744-0527  
 800-782-7706  
[www.whitehallmfg.com](http://www.whitehallmfg.com)



#563c

552b. Shower valve

**Ligature-Resistant Shower Valve – SV230**

Behavioral Safety Products  
 Watkinsville, GA 30677  
 706-705-1500  
[www.besafepro.com](http://www.besafepro.com)



#552b

552c. Shower valve

**834-S40 SRTM Retrofit Shower Knob**

Weizel Security  
 800-308-3627  
[www.securingshospitals.com](http://www.securingshospitals.com)



#552c

552d. Shower valve

**Sense™ DMV2 – Individual Shower concealed electronic mixing valve with optional stainless steel cover**

Armstrong International  
 Three Rivers, MI 49093  
 269-273-1415  
[www.armstronginternational.com](http://www.armstronginternational.com)



#552d

555a. Shower diverter valve

**834-SN2 SRTM Diverter Valve Assembly**

Weizel Security  
 800-308-3627  
[www.securingshospitals.com](http://www.securingshospitals.com)



#555a

*Inclusion or exclusion of a product does not indicate endorsement or disapproval of that product, nor does it suggest that any product is free of risk. All products must be in compliance with the organization's Environmental Safety Risk Assessment for each location.*

560a. Shower assembly  
**BestCare® Flush-Mount Ligature-Resistant Security Shower WH1741-CSH**

Whitehall Manufacturing  
 City of Industry, CA 91744-0527  
 800-782-7706  
[www.whitehallmfg.com](http://www.whitehallmfg.com)

#560a



560b. Shower assembly  
**SR834-S35 SRTM Shower Panel**

Weizel Security  
 800-308-3627  
[www.securingshospitals.com](http://www.securingshospitals.com)

#560b



560c. Shower assembly  
**Ligature-Resistant Shower Panel #SV710**

Behavioral Safety Products  
 Watkinsville, GA 30677  
 706-705-1500  
[www.besafepro.com](http://www.besafepro.com)

#560c



562. Shower assembly – recessed hand-held  
**M0418-E508 in locking box**

Acorn Engineering  
 City of Industry, CA 91746  
 800-488-8999  
[www.acorneng.com](http://www.acorneng.com)

#562

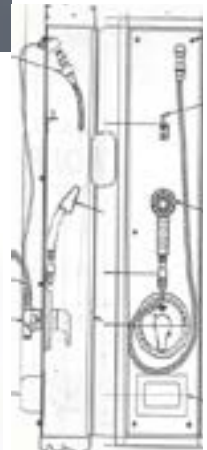

563a. Shower assembly – handicapped accessible  
**Dual Quick Connect – Wall Mounted Shower Head with Integral Diverter #42020US**

Intersan Manufacturing Company  
 Phoenix, AZ 85007  
 602-254-3101  
[www.intersan.us](http://www.intersan.us)

#563a



563b. Shower assembly – handicapped accessible

**Quick release hand held shower head; Model 40707**

Intersan Manufacturing Company

Phoenix, AZ 85007

800-999-3101

[www.intersanus.com](http://www.intersanus.com)



563c. Shower assembly – handicapped accessible

**BestCare® Flush-Mount Ligature-Resistant Security Shower with Dual Heads WH1741-FH-CSH**

Whitehall Manufacturing

City of Industry, CA 91744-0527

800-782-7706

[www.whitehallmfg.com](http://www.whitehallmfg.com)

**#563c**



## 22 43 23 – Shower Receptors and Basins

564a. Shower linear drain

**ProLine drain with “dots” cover**

QuickDrain USA

Frisco, CO 80443

866-998-6685

[www.quickdrainusa.com](http://www.quickdrainusa.com)

**#563c**



**#564a**

565a. Ligature Resistant Drain Cover

**Crocodile Roll Resistant Floor Drain; 303070X**

Intersan Manufacturing Company

Phoenix, AZ 85007

800-999-3101

[www.intersanus.com](http://www.intersanus.com)



**#565a**

565b. Ligature Resistant Drain Cover

**Tower Industries; Anti-Ligature Drain Cover – Model SDC-AL-1-S**

Tower Industries

Massillon, OH 44647

330-837-2216

[www.towershowers.com](http://www.towershowers.com)



**#565b**

*Inclusion or exclusion of a product does not indicate endorsement or disapproval of that product, nor does it suggest that any product is free of risk. All products must be in compliance with the organization's Environmental Safety Risk Assessment for each location.*

## 565c. Ligature Resistant Drain Cover

**BestCare® Ligature-Resistant Floor Drain Grate WHDG Series**

Whitehall Manufacturing  
 City of Industry, CA 91746  
 800-782-7706  
[www.whitehallmfg.com](http://www.whitehallmfg.com)



## 565d. Ligature Resistant Drain Cover

**BestCare® Ligature-Resistant Linear Drain with Flashing Flange WHLD Series**

Whitehall Manufacturing  
 City of Industry, CA 91746  
 800-782-7706  
[www.whitehallmfg.com](http://www.whitehallmfg.com)



## 566. One-piece patient toilet room floor

**UniFloor**

Bestbath®  
 Caldwell, ID 83605  
 800-727-9907  
[www.bestbath.com](http://www.bestbath.com)



## 567a. Shower floor basin

**The Swan Corporation, Swanstone Solid Surface Shower Floors**

The Swan Corporation  
 St. Louis, MO. 63101  
 1-314-231-8148  
[www.theswancorp.com](http://www.theswancorp.com)



## 567b. Shower floor basin

**Roll-in shower with front trench**

Watermark  
 Nashville, TN 37204  
 615-291-6111  
[www.watermarksolidsurface.com](http://www.watermarksolidsurface.com)

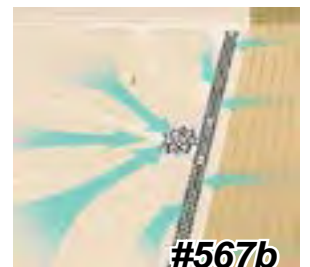

*Inclusion or exclusion of a product does not indicate endorsement or disapproval of that product, nor does it suggest that any product is free of risk. All products must be in compliance with the organization's Environmental Safety Risk Assessment for each location.*

## 567c. Shower floor basin

**AquaSurf solid surface shower bases**

Willoughby Industries  
Indianapolis, IN 46268  
800-428-4065  
[www.willoughby-ind.com](http://www.willoughby-ind.com)



#567c

## 568a. Pre-built bathrooms

**Pre-Built Bathrooms**

Eggrock, LLC  
Littleton, MA 01460  
978-952-8800  
[www.eggrock.com](http://www.eggrock.com)



#568a

## 568b. Pre-built bathrooms

**SurePods™**

Oldcastle®  
Orlando, FL 32837  
407-859-7034  
<https://oldcastlesurepods.com>

## 22 43 39 – Healthcare Faucets

## 570a. Lavatory faucet

**Ligature-Resistant Metering Faucet – SF380**

Behavioral Safety Products  
Watkinsville, GA 30677  
706-705-1500  
[www.besafepro.com](http://www.besafepro.com)



#570a

## 570b. Lavatory faucet

**Suicide Prevention Patient Sink Faucet**

Norva Plastics, Inc  
Norfolk, VA 23508  
800-826-0758  
[www.norvaplastics.com](http://www.norvaplastics.com)



#570b

Inclusion or exclusion of a product does not indicate endorsement or disapproval of that product, nor does it suggest that any product is free of risk. All products must be in compliance with the organization's Environmental Safety Risk Assessment for each location. This document is intended to represent leading current practices, in the opinion of the authors. It does not represent a minimum acceptable conditions or establish a legal "standard of care" that facilities are required to follow.



570c. Lavatory faucet

**BestCare® Ligature-resistant, ADA-compliant faucet  
3377 w/2 pneumatic buttons**

Whitehall Manufacturing  
City of Industry, CA 91744-0527  
800-782-7706  
[www.whitehallmfg.com](http://www.whitehallmfg.com)



**3570c**

570d. Lavatory faucet

**BestCare® Ligature-resistant, ADA-compliant Sensor  
faucet #WH3375-SO**

Whitehall Manufacturing  
City of Industry, CA 91744-0527  
800-782-7706  
[www.whitehallmfg.com](http://www.whitehallmfg.com)



**#570d**

574. Lavatory with countertop valve

**Lavatory Valve**

Odd Ball Industries  
Greenlawn, NY 11740  
631-754-0400  
[www.oddballindustries.com](http://www.oddballindustries.com)



**#574**

## 22 43 43 – Plumbing Fixture Flushometers

580. Recessed flush valve

**Royal 611 & WB-1-A Easy Access Wall Box**

Sloan®  
Franklin Park, IL 60131  
800-982-5839  
[www.sloan.com](http://www.sloan.com)

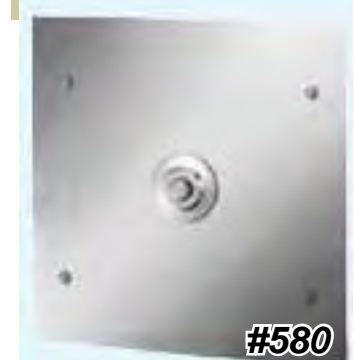

**#580**

581a. Recessed flush valve

**Regal 955 Hydraulic Concealed Flushometer & WB-1-A  
Easy Access Wall Box**

Sloan®  
Franklin Park, IL 60131  
800-982-5839  
[www.sloan.com](http://www.sloan.com)



**#581a**

*Inclusion or exclusion of a product does not indicate endorsement or disapproval of that product, nor does it suggest that any product is free of risk. All products must be in compliance with the organization's Environmental Safety Risk Assessment for each location.*

581b. Recessed flush valve

**CX Manual Flushometer (Recessed)**

Sloan®

Franklin Park, IL 60131

800-982-5839

[www.sloan.com](http://www.sloan.com)



**#581b**

581c. Recessed flush valve

**3-inch Push Button Assembly for Concealed Flush Valves – P6000-NL3**

Zurn Industries

Milwaukee, WI 53204

855-663-9876

[www.zurn.com](http://www.zurn.com)



**#585a**

585a. Flush valve cover

**HSC79 SafeCare Ligature-Resistant Flush Valve Cover**

Bradley Corporation

W142N9101 Fountain Boulevard Menomonee Falls, WI 53051

800-272-3539

[www.bradleycorp.com](http://www.bradleycorp.com)

585b. Flush valve cover

**FV500 (2 piece) & FV600 (1 piece) Ligature Resistant Flush Valve Cover**

Behavioral Safety Products

Watkinsville, GA 30677

706-705-1500

[www.besafepro.com](http://www.besafepro.com)



**#585b**

585c. Flush valve cover

**831-S39 SRTM Flush Valve Cover**

Weizel Security

Coquitlam, BC, Canada V3K 6V5

800-308-3627

[www.securingshospitals.com](http://www.securingshospitals.com)



**#585c**

*Inclusion or exclusion of a product does not indicate endorsement or disapproval of that product, nor does it suggest that any product is free of risk. All products must be in compliance with the organization's Environmental Safety Risk Assessment for each location.*

585d. Flush valve cover

**Ligature-Resistant Box with Flush Valve WH2802 – for various toilet or urinal**

Whitehall Manufacturing  
City of Industry, CA 91744-0527  
800-782-7706  
[www.whitehallmfg.com](http://www.whitehallmfg.com)



588. Recessed bedpan washer

**Recessed Bedpan Washer**

Willoughby Industries  
Indianapolis, IN 46268  
800-428-4065  
[www.willoughby-ind.com](http://www.willoughby-ind.com)

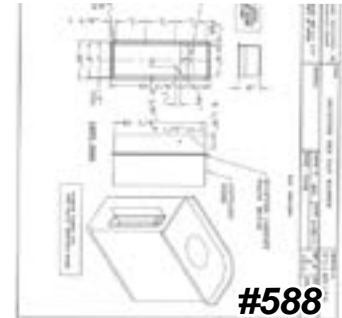

## 22 47 00 – Water Station Water Coolers

589a. Drinking water cup filling stations

**B103-C2-HR Water Bottle Filling Station Cup Dispenser and Disposal with security features**

Filtrine Manufacturing Company  
Keene, NH 03431  
800-930-3367  
[www.filtrine.com](http://www.filtrine.com)



589b. Drinking water cup filling stations

**Quench 755 Countertop Filtered Water Cooler with UV**

Quench  
King of Prussia, PA 19406  
888-877-0561  
[www.quenchonline.com](http://www.quenchonline.com)



*Inclusion or exclusion of a product does not indicate endorsement or disapproval of that product, nor does it suggest that any product is free of risk. All products must be in compliance with the organization's Environmental Safety Risk Assessment for each location.*

589c. Drinking water cup filling stations

**Pushbutton Ligature-Resistant Cup Filler – WHBF3**

Whitehall Manufacturing  
 City of Industry, CA 91744-0527  
 800-782-7706  
[www.whitehallmfg.com](http://www.whitehallmfg.com)



## 22 60 00 – Gas and Vacuum Systems

590a. Medical gas covers

**Security Patient Console**

Hospital Systems, Inc.  
 Pittsburg, CA 94565  
 925-427-7800  
[www.hsiheadwalls.com](http://www.hsiheadwalls.com)



590b. Medical gas covers

**Recessed Security Console**

Modular Services Company  
 Oklahoma City, OK 73114  
 800-687-0938  
[www.modularservices.com/products-services/](http://www.modularservices.com/products-services/)



590c. Medical gas covers

**Security Headwalls w/ 3/8" polycarbonate locked cover bottom hinge**

Modular Services Company  
 Oklahoma City, OK 73114  
 800-687-0938  
[www.modularservices.com](http://www.modularservices.com)  
[www.filtrine.com](http://www.filtrine.com)



*Inclusion or exclusion of a product does not indicate endorsement or disapproval of that product, nor does it suggest that any product is free of risk. All products must be in compliance with the organization's Environmental Safety Risk Assessment for each location.*

## 23 00 00 – Heating, Ventilating, A/C

### 23 37 13 – Diffusers, Registers and Grilles

600a. Air grille - “S” vane

**Security Grille – “S” vane # RSPA41**

Carnes® Company

Verona, WI 53593

608-845-6411

[www.carnes.com](http://www.carnes.com)

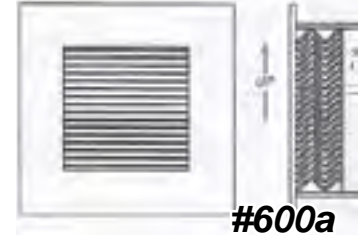

600c. Air grille - “S” vane

**V-Vent High Security Grille #814-R17 SRTM**

Weizel Security

800-308-3627

[www.securingshospitals.com](http://www.securingshospitals.com)

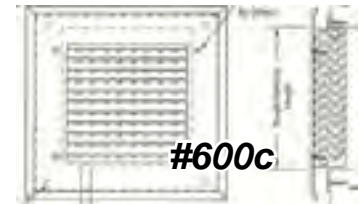

600d. Air grille - “S” vane

**Maximum Security Ceiling Diffuser # SV432**

Anemostat® Air Distribution

Carson, CA. 90745

310-835-7500

[www.anemostat.com](http://www.anemostat.com)

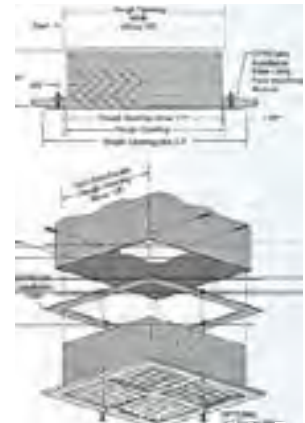

602a. Air grille – max security

**Extra Heavy Duty Grille with Removable Steel Perforated Face Plate # RRMX**

Anemostat® Air Distribution

Carson, CA. 90745

310-835-7500

[www.anemostat.com](http://www.anemostat.com)



*Inclusion or exclusion of a product does not indicate endorsement or disapproval of that product, nor does it suggest that any product is free of risk. All products must be in compliance with the organization's Environmental Safety Risk Assessment for each location.*

602b. Air grille – max security

**Maximum Security Suicide Deterrent Grille, steel with 3/16-inch holes # SG-SD**

Titus

Plano, TX 75074

972-212-4800

[www.titus-hvac.com](http://www.titus-hvac.com)



603a. Air grilles - Perforated

**Security Grille – Perforated # RSPA51**

Carnes® Company

Verona, WI 53593

608-845-6411

[www.carnes.com](http://www.carnes.com)



603b. Air grilles - Perforated

**Security Grille – supply or return # SEG-4P3**

Kees Incorporated

Elkhart Lake, WI 53020-0327

920-876-3391

[www.kees.com](http://www.kees.com)

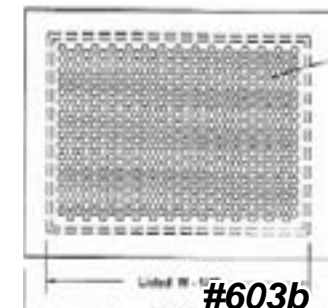

603c. Air grilles - Perforated

**Ligature-Resistant Exhaust/Supply Grille #EG450**

Behavioral Safety Products

Watkinsville, GA 30677

706-705-1500

[www.besafepro.com](http://www.besafepro.com)



**#603c**

*Inclusion or exclusion of a product does not indicate endorsement or disapproval of that product, nor does it suggest that any product is free of risk. All products must be in compliance with the organization's Environmental Safety Risk Assessment for each location.*



606a. Fan coil enclosures

**Fan Coil Covers - Security**

ARSCO Manufacturing Company  
 Cincinnati, OH 45248  
 800-543-7040  
[www.arscomfg.com](http://www.arscomfg.com)

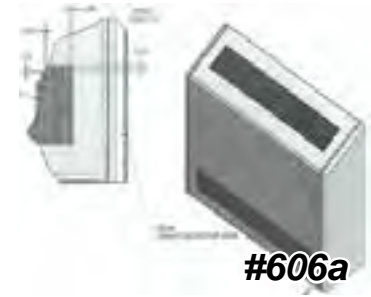

609b. Air grilles - Perforated

**Ligature-Resistant PTAC Cover #TA640**

Behavioral Safety Products  
 Watkinsville, GA 30677  
 706-705-1500  
[www.besafepro.com](http://www.besafepro.com)



607a. Room Temperature Sensor – tamper-resistant

**Flush-Mount Thermistor; KTP Series Stainless Steel**

Kele, Inc.  
 Bartlett, TN 38133  
 877-826-9045  
[www.kele.com](http://www.kele.com)



607b. Room Temperature Sensor – tamper-resistant

**Flush-Mount Room Temperature Sensor #540-520**

Siemens Building Technologies, Inc.  
 1000 Deerfield Parkway  
 Buffalo Grove, IL 60089  
[www.siemens.com](http://www.siemens.com)

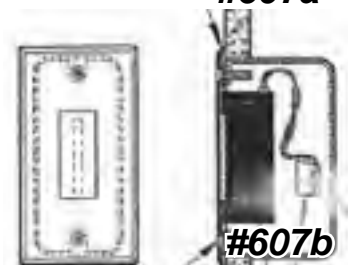

*Inclusion or exclusion of a product does not indicate endorsement or disapproval of that product, nor does it suggest that any product is free of risk. All products must be in compliance with the organization's Environmental Safety Risk Assessment for each location.*

## 26 27 26 – Electrical Devices

610a. Hospital-grade receptacles

**Hospital Grade Tamper-Resistant GFCI Receptacles**

Hubbell Incorporated

Shelton, CT 06484

800-288-6000

[www.hubbell-wiring.com](http://www.hubbell-wiring.com)



#610a

610b. Hospital-grade receptacles

**Hospital Grade Tamper-Resistant GFCI Receptacles**

Cooper Industries

Houston, TX 77210-4446

713-209-8400

[www.cooperindustries.com](http://www.cooperindustries.com)



#611a

611a. Key-operated electric switches

**Pass & Seymour Locking Keyed Switch**

Legrand North America, LLC

<http://www.legrand.us/passandseymour.aspx>



#611b

611b. Key-operated electric switches

**Leviton 1221-2KL Key Locking Extra Heavy Duty Switch**

Leviton Manufacturing Co., Inc.

[www.leviton.com](http://www.leviton.com)

612a. Polycarbonate electrical coverplates

**Tiger Plates**

Cortech® USA

Willowbrook, IL 60527

800-571-0700

[www.cortechusa.com](http://www.cortechusa.com)



#612a

*Inclusion or exclusion of a product does not indicate endorsement or disapproval of that product, nor does it suggest that any product is free of risk. All products must be in compliance with the organization's Environmental Safety Risk Assessment for each location.*

## 26 51 00 – Interior Lighting

620a. Light fixture

**NASL-RND LED 2' diameter w/ flat polycarbonate lens**

Day-O-Lite

Warwick, RI 02888

401-467-8232

[www.dayolite.com](http://www.dayolite.com)

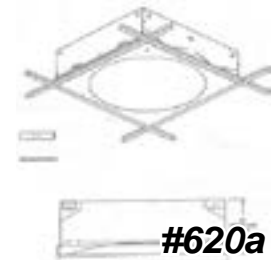

620b. Ambient or overbed light

**Symmetry tamper-resistant light fixture**

Visa Lighting

Milwaukee, WI 53209

[www.visalighting.com](http://www.visalighting.com)



620c. Light fixture

**Fino® ceiling mount and wall mount light fixtures**

Amerlux®, LLC

Oakland, NJ 07436

973-882-5010

[www.amerlux.com](http://www.amerlux.com)

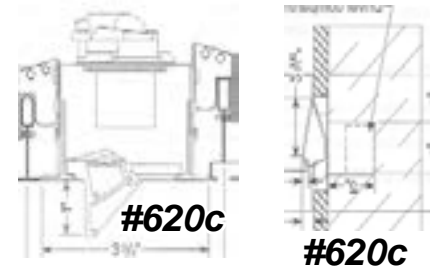

620d. Light fixture

**Mighty Mac TW Series TUNABLE Color SSA Slope Sided Surface Mount or RMCD Recessed Mount vandal resistant light fixtures**

Kenall®

Kenosha, WI 53144

800-453-6255

[www.kenall.com](http://www.kenall.com)



620e. Light fixture

**Fail-Safe SGI recessed, sealed, and gasketed with polycarbonate lens**

Eaton's Cooper Lighting

Peachtree City, GA 30269

770-486-4800

[www.cooperindustries.com](http://www.cooperindustries.com)



*Inclusion or exclusion of a product does not indicate endorsement or disapproval of that product, nor does it suggest that any product is free of risk. All products must be in compliance with the organization's Environmental Safety Risk Assessment for each location.*

620f. Light fixture

**818-R13 SRTM Recessed Ceiling Lighting with polycarbonate lens**

Weizel Security

800-308-3627

[www.securingshospitals.com](http://www.securingshospitals.com)



620g. Light fixture

**Serenity – Serenity Series**

Visa Lightin

Milwaukee, WI 53209

800-788-8472

[www.visalighting.com](http://www.visalighting.com)



620h. Light fixture

**Ligature & Vandal-Resistant 6” LED downlight #MRV-06858**

Kirlin Company

Detroit, MI 48207

313-259-6400

[www.kirlinlighting.com](http://www.kirlinlighting.com)



620j. Light fixture

**Sonar 12 SPC12 Vandal Resistant wall mount fixture**

Luminaire Lighting Corporation

P. O. Box 2162

Edison, NJ 08818

732-549-0056

[www.luminairelighting.com](http://www.luminairelighting.com)



620k. Light fixture

**Shat-R-Shield - Ironclad VR Pro surface mounted vandal-resistant fixture #494F12**

Grainger

Lake Forest, IL 60045

800-472-4643

[www.grainger.com](http://www.grainger.com)



620l. Light fixture

**Vandal Resistant round wall/ceiling mount fixture Anyx-13, ARV-13**

Luminaire Lighting Corporation

Edison, NJ 08818

732-549-0056

[www.luminairelighting.com](http://www.luminairelighting.com)



*Inclusion or exclusion of a product does not indicate endorsement or disapproval of that product, nor does it suggest that any product is free of risk. All products must be in compliance with the organization's Environmental Safety Risk Assessment for each location.*

620m. Light fixture

**Kenall MedMaster MedSlot Series**

Kenall®  
 Kenosha, WI 53144  
 800-453-6255  
[www.kenall.com](http://www.kenall.com)



#620m

620n. Light fixture

**Fail-Safe FW WaveStream Wall LED Luminaire**

Eaton Lighting  
 770-486-4800  
[www.eaton.com/lighting](http://www.eaton.com/lighting)



#620n

624. Individual reading light

**Visa Lighting; Gig with BH1 mounting bracket & polycarbonate lens**

Visa Lighting  
 Milwaukee, WI 53209  
 800-788-8472  
[www.visalighting.com](http://www.visalighting.com)



#624

630. Downlight cover

**Recesso Lights**

Recesso Lighting by Dolan Designs  
 Kirkland, WA 98034  
 877-357-6127  
<http://recessolighting.com>



#630

637. Exterior lighting

**Exterior Vandal Resistant Lighting**

The Kirlin Company  
 Detroit, MI 48207  
 313-259-6400  
[www.kirlinlighting.com](http://www.kirlinlighting.com)

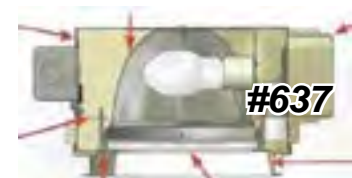

#637

*Inclusion or exclusion of a product does not indicate endorsement or disapproval of that product, nor does it suggest that any product is free of risk. All products must be in compliance with the organization's Environmental Safety Risk Assessment for each location.*

639a. Night-light

**LNT-03092 Night Light**

The Kirlin Company

Detroit, MI 48207

313-259-6400

[www.kirlinlighting.com](http://www.kirlinlighting.com)



639b. Night-light

**CM-25500 PathMaster Step Light**

Phillips Lighting North America Corp.

(Chloride)

Somerset, NJ 08873

855-486-2216

[www.lightingproducts.phillips.com](http://www.lightingproducts.phillips.com)



## 26 53 00 – Exit Signs

640a. Exit signs, LED – vandal-resistant

**Commercial Exist Signs SC Series – Cast Aluminum LED with lens and tamperproof hardware**

Phillips Lighting North America Corporation (Chloride)

Somerset, NJ 08873

855-486-2216

[www.lightingproducts.phillips.com](http://www.lightingproducts.phillips.com)



640b. Exit signs, lighted – vandal-resistant

**Mighty Mac MMEX Surface, Wall, or Ceiling Mount Single/Double Face Exit w/ full-length mounting canopy**

Kenall®

Kenosha, WI 53144

800-453-6255

[www.kenall.com](http://www.kenall.com)



642. Exit signs - photoluminescent

**EX424246-100G Ecoglo® Photoluminescent Exit Sign**

Access Products Inc.

Buffalo, NY 14203

888-679-4022

[www.us.ecoglo.com](http://www.us.ecoglo.com)

#640b

*Inclusion or exclusion of a product does not indicate endorsement or disapproval of that product, nor does it suggest that any product is free of risk. All products must be in compliance with the organization's Environmental Safety Risk Assessment for each location.*



## 26 55 53 – Security Lighting

643. Covers

### **Norva Plastics – Life/Fire Safety Lexan Covers**

Norva Plastics, Inc

Norfolk, VA 23508

800-826-0758

[www.norvaplastics.com](http://www.norvaplastics.com)



**#643**

## 27 00 00 – Communications

### 27 32 13 – Telephone Sets

645a. Stainless steel wall phones

### **GB306V-14 Vandal-Resistant Telephone with 14" armored cord**

Allen Tel Products, Inc.

Henderson, NV 89014

702-855-5700

[www.allentel.com](http://www.allentel.com)



**#645a**

645b. Stainless steel wall phones

### **SSW-321-X Ceeco Stainless Steel Wall Phone**

[TWAComm.com](http://TWAComm.com)

Fountain Valley, CA 92708

877-389-0000

[www.twacomm.com](http://www.twacomm.com)



**#645b**

645c. Stainless steel wall phones

### **JP3500 Armored Courtesy Phone**

G-Tel Enterprises, Inc.

Houston, TX 77084

800-884-4835

[www.payphone.com](http://www.payphone.com)



**#645c**

*Inclusion or exclusion of a product does not indicate endorsement or disapproval of that product, nor does it suggest that any product is free of risk. All products must be in compliance with the organization's Environmental Safety Risk Assessment for each location.*

## 27 52 23 – Nurse Call/Code Blue Systems

650a. Wireless duress alarm

**INSTANTalarm® 5000**

Pinpoint®, Inc.

Birmingham, AL 35209

205-414-7541

[www.pinpointinc.com](http://www.pinpointinc.com)



#650a

650f. Wireless duress alarm

**B3000n Communication Badge**

Vocera®

San Jose, CA 95126

888-986-2372

[www.vocera.com](http://www.vocera.com)



#650f

653. Nurse call system – vandal-resistant

**HSS401 Responder Health Care Communications System High Security Staff Duty Station**

Rauland-Borg Corporation

Mount Prospect, IL 60056

800-752-7725

[www.rauland.com](http://www.rauland.com)

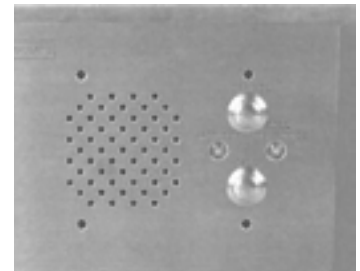

#653

654. Pushbutton switch – vandal-resistant

**PV1-PV8 Anti-Vandal Switches**

Lamb Industries

Minneapolis, MN 55428

800-867-2717

<http://www.e-switch.com/>



#654

*Inclusion or exclusion of a product does not indicate endorsement or disapproval of that product, nor does it suggest that any product is free of risk. All products must be in compliance with the organization's Environmental Safety Risk Assessment for each location.*

## 28 00 00 – Electronic Safety and Security

### 28 40 00 – Electronic Monitoring and Control

660. Metal Detectors

**Metrasens; Proscreen 200**

Metrasens

Lisle, IL 60532

630-541-6509

<http://www.metrasens.com/>



#660

## 32 00 00 – Exterior Improvements

### 32 31 13 – Security Fencing

675a. Security fencing

**Mini-Mesh chain-link fencing**

Fence Factory

Agoura Hills, CA 91301

800-613-3623

[www.fencefactory.com](http://www.fencefactory.com)



#675a

675b. Security fencing

**WireWall® High Security Fencing - Maximum Security**

Riverdale Mills Corporation

Northbridge, MA 01534

800-762-6374

[www.riverdale.com](http://www.riverdale.com)



#675b

675c. Security fencing

**Steel fence systems**

METALCO Fence & Railing Systems, Inc.

Las Vegas, NV 89102

800-708-2526

[fence-system.com](http://fence-system.com)



#675c

*Inclusion or exclusion of a product does not indicate endorsement or disapproval of that product, nor does it suggest that any product is free of risk. All products must be in compliance with the organization's Environmental Safety Risk Assessment for each location.*

675d. Security fencing

**Fortress Fencing**

Britplas

Woolston

Warrington, Cheshire, England WA1 4RW

+44(01)-1925-824317

[www.britplas.com](http://www.britplas.com)



## About the Authors

**Kimberly Newton McMurray, AIA, EDAC, NCARB, MBA** is Principal of Behavioral Health Facility Consulting, LLC. of Tuscaloosa, Alabama; an organization that consults with behavioral health organizations and architects who design behavioral health facilities regarding their unique requirements for patient and staff safety. McMurray is a licensed architect and healthcare planner with over 35 years of project leadership experience in healthcare and academic medical campus architecture; she has been responsible for the implementation of large architectural projects located within complex medical campus sites, delivering the highest quality for each project initiative. McMurray has a decade of experience from the owner's perspective and working with multi-disciplinary user groups, thereby embracing a unique perspective and response to client needs; applying her knowledge of clinical operations, evidence-based design, lean operational planning and conceptual design to architecture. Among McMurray's three decades of healthcare architectural expertise, she brings a high-level of experience with behavioral and mental health project types. She has assisted in over 65 behavioral and mental health facility space programs, master plans, designs and PSSRs since joining BHFC in 2017. She can be reached at [kimberly@bhfcllc.com](mailto:kimberly@bhfcllc.com).

**James M. Hunt, AIA**, is a retired architect and facility management professional with more than 40 years of experience. He is a registered architect and began his career practicing architecture for several major health care projects. He then served as director of facility management for the Menninger Clinic for 20 years. In addition to managing the clinic's main campus, he consulted on behavioral health care unit remodeling projects for their Clinical Network program in eight states. During this time, Mr. Hunt was a founding member of the Health Care Council of the International Facility Management Association. He held several offices in the council, including chair. He publishes articles and speaks at major conferences frequently. He is founder and Retired Consultant of Behavioral Health Facility Consulting, LLC (BHFC). He has worked with behavioral health facilities in more than 40 years and may be reached at [www.bhfcllc.com](http://www.bhfcllc.com).

**David M. Sine, DrBE, CSP, ARM, CPHRM** - 25 years in safety, risk management, human factors, and organizational consulting. He has been state safety director of two eastern states, senior staff engineer for the Joint Commission, and a senior consultant for the American Hospital Association. Founding partner and one-time contributing editor for Briefings on Hospital Safety, co-author of Quality Improvement Techniques for Hospital Safety, and one-time vice chair of the board of Brackenridge Hospital in Austin, Texas, Mr. Sine is certified by the Joint Board of the American Board of Industrial Hygiene and Certified Safety Professionals and as a Certified Professional Healthcare Risk Manager by ASHRM. He has been a health care risk management consultant since 1980 and has conducted more than 1,300 Joint Commission compliance assessment surveys. He serves as a member of the NFPA 101 Life Safety Code Subcommittee on Health Care Occupancies, the Joint Commission Committee on Healthcare Safety, and the FGI Health FGI Guidelines Revision Committee and acts as a risk management adviser to the National Association of Psychiatric Health Systems. He served in the corporate offices of the Tenet Health System in Dallas as director of risk assessment and loss prevention and vice president of occupational health and safety. Mr. Sine continues to write and lecture extensively on health care policy, governance, quality improvement, and risk management as President of SafetyLogic Systems. He can be reached at [dsine9@gmail.com](mailto:dsine9@gmail.com).

*Inclusion or exclusion of a product does not indicate endorsement or disapproval of that product, nor does it suggest that any product is free of risk. All products must be in compliance with the organization's Environmental Safety Risk Assessment for each location.*

## List of Manufacturers

Access Products, <a href="http://www.us.ecoglo.com">www.us.ecoglo.com</a>	Big John, <a href="http://www.bigjohntoiletseat.com">www.bigjohntoiletseat.com</a>
Accurate, <a href="http://www accuratelockandhardware.com">www accuratelockandhardware.com</a>	Blockhouse, <a href="http://www.blockhouse.com">www.blockhouse.com</a>
Ace Security, <a href="http://www.smashandgrab.com">www.smashandgrab.com</a>	Bradley, www.bradleycorp.com
Acorn Engineering Co., <a href="http://www.acorneng.com">www.acorneng.com</a>	Brey-Krause www.breykrause.com
Allen Tel Products, www.allentel.com	Britplas, www.britplas.com
Alro Plastics, <a href="http://www.alro.com">www.alro.com</a>	Carnes, www.carnes.com
American Innovation, www.americaninnovationproducts.com	Carstens, <a href="http://www.carstens.com">www.carstens.com</a>
American Specialties, www.americanspecialties.com	Cascade, www.cascadesh.com
American Standard, <a href="http://www.americanstandard-us.com/">www.americanstandard-us.com/</a>	Ceco, <a href="http://www.cecodoor.com">www.cecodoor.com</a>
Anemostat, www.anemostat-hvac.com	CHG, www.chgbeds.com
Archer Manufacturing, www.vandalproof.org	Chloride, www.chloridesys.com/chloride
Armstrong Ceiling Solutions, <a href="http://www.armstrongceilings.com">www.armstrongceilings.com</a>	CompX, www.compx.com
Armstrong Flooring, www.armstrong.com	Comfortex, www.comfortex.com
Armstrong International, <a href="http://armstronginternational.com">http://armstronginternational.com</a>	Cooper, www.cooperindustries.com
Arsco, <a href="http://www.arscomfg.com">www.arscomfg.com</a>	Cortech, www.cortechusa.com
Avonite, www.avonitesurfaces.com	CS Acrovyn, www.c-sgroup.com
BASF, <a href="http://www.master-builders-solutions.basf.us">www.master-builders-solutions.basf.us</a>	Curries, www.curries.com
Behavioral Safety Products, www.besafepro.com	Custom Design Frameworks, www.customdesignframeworks.com
Best Access Solutions, Inc., <a href="http://www.bestaccess.com/index.php/products/behavioral-health-products/">http://www.bestaccess.com/index.php/products/behavioral-health-products/</a>	Dano Group, <a href="http://www.danogroup.com">http://www.danogroup.com</a>
Bath, www.best-bath.com	Designplan, www.designplan.com

*Inclusion or exclusion of a product does not indicate endorsement or disapproval of that product, nor does it suggest that any product is free of risk. All products must be in compliance with the organization's Environmental Safety Risk Assessment for each location.*



Dex-O-Tex, www.dexotex.com	Hospital Systems Inc., www.HospitalSystems.com
DHSI, www.dhsi-seal.com	Hubbell, www.hubbell-wiring.com
Door Control Services, www.doorcontrolsusa.com	IE; Blinds, www.ieblinds.com
Door Switch, http://thedoorswitch.com	Intersan, www.intersan.us
Draper, Inc., www.draperinc.com	Ives, http://us.allegion.com/
Dur-A-Flex, www.dur-a-flex.com	J. L. Industries, www.jlindustries.com
Dynalock Corp, www.dynalock.com	Johnsonite, www.roppe.com
Eggrock, www.eggrock.com	Kane Mfg., www.kanescreens.com
Fence Factory, www.fencefactory.com	Kawneer Company, Inc., www.kawneer.com
Filtrine Manufacturing Co.; www.filtrine.com	Kees, www.kees.com
Flexco, www.flexcofloors.com/	Kele, Inc., <a href="http://www.kele.com">www.kele.com</a>
Flxsigns, www.290signs.com	Kenall, www.kenall.com
G-Tel, www.payphone.com/	Kennon Products, www.suicideproofing.com
Glasspec Corporation, www.glasspec.com	King Architectural Products, www.kingarchitecturalproducts.com
Global, www.security-glazing.com	Kingsway Group USA www.kingswaygroupusa.com
GoJo Industries, www.GOJO.com	Kirlin, www.kirlinlighting.com
Grahan Wood Doors, www.grahamdoors.com	Kwalu, www.kwalu.com
Grainger, www.grainger.com	L. C. Doane, www.lcdoane.com
Hafele, www.hafele.com/us/index.htm	LCN, http://us.allegion.com/brands/lcn/Pages/default.aspx
Hager Companies, www.hagerco.com	Lamb Industries, <a href="http://www.e-switch.com">www.e-switch.com</a>
Harm Reduction Solutions, www.harmreductionsolutions.com	

*Inclusion or exclusion of a product does not indicate endorsement or disapproval of that product, nor does it suggest that any product is free of risk. All products must be in compliance with the organization's Environmental Safety Risk Assessment for each location.*

Lee's Carpet,  
[www.leescarpets.com](http://www.leescarpets.com)

Lonseal,  
<http://lonseal.com>

Luminaire,  
[www.luminairelighting.com](http://www.luminairelighting.com)

Manko Windows,  
[www.mankowindows.com](http://www.mankowindows.com)

Maiman,  
[www.maiman.com](http://www.maiman.com)

Marathon,  
[www.flexcofloors.com](http://www.flexcofloors.com)

Markar,  
<https://www.assaabloydooraccessories.us/en/local/assaabloydooraccessoriesus/products/hinges/continuous-pin-barrel-hinges/behavioral-health-hinges/>  
Marks USA,  
[www.marksusa.com](http://www.marksusa.com)

Marshfield Door Systems, [www.marshfielddoors.com](http://www.marshfielddoors.com)

McMaster-Carr,  
[www.mcmaster.com](http://www.mcmaster.com)

Metalco,  
[www.fence-system.com](http://www.fence-system.com)

Metrasens,  
[www.metrasens.com](http://www.metrasens.com)

Mockett, Doug,  
[www.mockett.com](http://www.mockett.com)

Moduform,  
[www.moduform.com](http://www.moduform.com)

Modular Services Company,  
[www.modularservices.com](http://www.modularservices.com)

National Gypsum,  
[www.nationalgypsum.com](http://www.nationalgypsum.com)

Nemschoff,  
[www.nemschoff.com](http://www.nemschoff.com)

Nora Systems, Inc.;  
[www.nora.com/us](http://www.nora.com/us)

Norix,  
[www.norix.com](http://www.norix.com)

Northwest Specialty Hardware.  
[www.northwestsh.com](http://www.northwestsh.com)

Norva Plastics,  
[www.norvaplastics.com](http://www.norvaplastics.com)

Odd Ball,  
[www.oddballindustries.com](http://www.oddballindustries.com)

O'Keeffe's, Inc.,  
[www.safti.com](http://www.safti.com)

Oldcastle,  
[www.oldcastlebe.com](http://www.oldcastlebe.com)

Pabco Gypsum,  
[www.quietrock.com](http://www.quietrock.com)

Padded Surfaces,  
[paddedsurfaces.com/CAD.html](http://paddedsurfaces.com/CAD.html)

Pecora,  
[www.pecora.com](http://www.pecora.com)

Peerless A-V,  
[www.perlessmounts.com](http://www.perlessmounts.com)

Pineapple,  
[www.pineapplecontracts.com](http://www.pineapplecontracts.com)

Pinpoint,  
[www.pinpointinc.com](http://www.pinpointinc.com)

Quench;  
[www.quenconline.com](http://www.quenconline.com)

Quick Drain USA,  
[www.quickdrain.com](http://www.quickdrain.com)

RAL & Associates,  
[www.ieblinds.com](http://www.ieblinds.com)

Rauland - Borg Corp.,  
[www.rauland.com](http://www.rauland.com)

Re\*cesso Lights,  
<http://recessolighting.com/>

Riverdale Mills,  
[www.wirewall.com](http://www.wirewall.com)

ROA Contract Sales,  
[www.rao.com](http://www.rao.com)

Rockwood,  
[www.rockwoodmfg.com](http://www.rockwoodmfg.com)

Roppe,  
[www.roppe.com](http://www.roppe.com)

Sabic,  
[www.sabic.com](http://www.sabic.com)

*Inclusion or exclusion of a product does not indicate endorsement or disapproval of that product, nor does it suggest that any product is free of risk. All products must be in compliance with the organization's Environmental Safety Risk Assessment for each location.*

SaftiFirst (O’Keeffe’s, Inc.), <a href="http://www.safti.com">www.safti.com</a>	Technical Glass Products (TGP), <a href="http://www.fireglass.com">www.fireglass.com</a>
Safehinge-Primera <a href="http://www.safehingeprimera.com">www.safehingeprimera.com</a>	This End Up, <a href="http://www.thisendup.com">www.thisendup.com</a>
Sani-liner, <a href="http://www.wisconsinconverting.com">www.wisconsinconverting.com</a>	3M, <a href="http://www.3m.com">www.3m.com</a>
Sargent Lock, <a href="http://www.sargentlock.com">www.sargentlock.com</a>	Titus, <a href="http://www.titus-hvac.com">www.titus-hvac.com</a>
Schlage, <a href="http://us.allegion.com">http://us.allegion.com</a>	Top Knobs, <a href="http://www.myknobs.com">www.myknobs.com</a>
Scotchshield, <a href="http://solutions.3m.com/">http://solutions.3m.com/</a>	Total Door, <a href="http://www.total-door.com">www.total-door.com</a>
Securitech Group, Inc., <a href="http://www.securitech.com">www.securitech.com</a>	Total Lock and Security, <a href="http://www.totallock.com">www.totallock.com</a>
Sheffield, <a href="http://www.sheffieldplastics.com">www.sheffieldplastics.com</a>	Townsteel, <a href="http://www.townsteel.com">www.townsteel.com</a>
Sherwood Windows Group, <a href="http://www.sherwoodwindows.com">www.sherwoodwindows.com</a>	Truebro, <a href="http://www.truebro.com/plumbing/truebro/lavshield">www.truebro.com/plumbing/truebro/lavshield</a>
Siemens Building Technology, <a href="http://www.siemens.com">www.siemens.com</a>	Truth Hdw., <a href="http://www.truth.com">www.truth.com</a>
Sizewise, <a href="http://www.sizewise.net">www.sizewise.net</a>	TWA Comm, <a href="http://www.twacomm.com">www.twacomm.com</a>
Sloan, <a href="http://www.sloanvalve.com">www.sloanvalve.com</a>	2/90 Sign Systems, <a href="http://www.290signs.com">www.290signs.com</a>
Spec, <a href="http://www.specfurniture.com">www.specfurniture.com</a>	Tyco, <a href="http://www.tyco-fire.com">www.tyco-fire.com</a>
Stanley Hardware, <a href="http://www.stanleyhardware.com">www.stanleyhardware.com</a>	Umano Medical, Inc., <a href="http://www.umanomedical.com">www.umanomedical.com</a>
Stanley Security, <a href="http://www.stanleysecuritysolutions.com">www.stanleysecuritysolutions.com</a>	Unicel, <a href="http://www.unicelarchitectural.com/en/index.php">www.unicelarchitectural.com/en/index.php</a>
Sto Americas, <a href="http://www.stocorp.com">www.stocorp.com</a>	USG Sheetrock, <a href="http://www.usg.com/content/usgcom/en.html">www.usg.com/content/usgcom/en.html</a>
Stryker, <a href="http://www.stryker.com/en-us/products/">www.stryker.com/en-us/products/</a>	Visa Lighting, <a href="http://www.visalighting.com">www.visalighting.com</a>
Sugatsune, <a href="http://www.sugatsune.com">www.sugatsune.com</a>	Vistamatic, <a href="http://www.vistamaticvisionpanels.com">www.vistamaticvisionpanels.com</a>
Surebond, <a href="http://www.surebond.com">www.surebond.com</a>	Vocera, <a href="http://www.vocera.com">www.vocera.com</a>
SydLo Design, LLC, <a href="mailto:lrwendt02@gmail.com">lrwendt02@gmail.com</a>	Wausau Windows, <a href="http://www.wausauwindow.com">www.wausauwindow.com</a>
Tamperproof Screws, <a href="http://www.tamperproof.com">www.tamperproof.com</a>	Webb Shade, <a href="http://www.webbshade.com">www.webbshade.com</a>

*Inclusion or exclusion of a product does not indicate endorsement or disapproval of that product, nor does it suggest that any product is free of risk. All products must be in compliance with the organization’s Environmental Safety Risk Assessment for each location.*

Weizel Security,  
[www.securingshospitals.com](http://www.securingshospitals.com)

Whitehall,  
[www.whitehallmfg.com](http://www.whitehallmfg.com)

Willoughby Industries,  
[www.willoughby-ind.com](http://www.willoughby-ind.com)

Zurn,  
[www.zurn.com](http://www.zurn.com)